



SPLIT-TYPE AIR CONDITIONER

	INDOOR	OUTDOOR
MODEL CODE	AR09HSFNBWKNET	AR09HSFNBWKXET
	AR12HSFNBWKNET	AR12HSFNBWKXET
	AR09HSFSBWKNZE	AR09HSFSBWKXZE
	AR09HSFNBWKNZE	AR09HSFNBWKXZE
	AR12HSFSAWKNZE	AR12HSFSAWKXZE
	AR12HSFNBWKNZE	AR12HSFNBWKXZE
	AR12HSFSRWKNER	AR12HSFSRWKXER
	AR12HSFNRWKNER	AR12HSFNRWKXER
	AR09HSSDRWKNER	AR09HSSDRWKXER
	AR09HSFSBWKNET	AR09HSFSBWKXET
	AR09HSFSBURNZE	AR09HSFSBURXZE
	AR12HSFSBURNZE	AR12HSFSBURXZE
	AR09HSFNCWKNZE	AR09HSFNCWKXZE
	AR12HSFNCWKNZE	AR12HSFNCWKXZE
	AR09HSFSBURNET	AR09HSFSBURXET
	AR12HSFSBURNET	AR12HSFSBURXET
	AR09HSFNCWKNET	AR09HSFNCWKXET
	AR12HSFNCWKNET	AR12HSFNCWKXET

BASIC CODE AR12HSFSAWKNET AR12HSFSAWKXET

SERVICE *Manual*

AIR CONDITIONER



CONTENTS

1. Precautions
2. Product Specifications
3. Alignment and Adjustments
4. Disassembly and Reassembly
5. Disassembly WIFI
6. Electrical Parts List
7. Wiring Diagram
8. PCB Diagram
9. Operating Instructions
10. Troubleshooting
11. Block Diagram
12. Reference Sheet

Refer to the service manual in the GSPN (see the rear cover) for the More information

Contents

1. Precautions	1-1
1-1 Installing the air conditioner.....	1-1
1-2 Power supply and circuit breaker.....	1-1
1-3 During operation	1-1
1-4 Disposing of the unit.....	1-2
1-5 Others	1-2
2. Product Specifications	2-1
2-1 The Feature of Product	2-1
2-2 Product Specifications	2-2
2-3 The Comparative Specifications of Product.....	2-6
2-4 Accessory and Option Specifications	2-8
3. Alignment and Adjustments	3-1
3-1 Test Mode.....	3-1
3-2 Outdoor LED Display Error and Check Method	3-2
3-3 Setting Option Setup Method.....	3-5
3-4 Setting Option Setup Method.....	3-9
4. Disassembly and Reassembly	4-1
4-1. Indoor Unit.....	4-2
4-2. Outdoor Unit.....	4-12
5. Disassembly WIFI	5-1
5-1 WIFI Case.....	5-1
5-2 ASSY CONTROL IN	5-2
5-3 Assy Control Out	5-4
6. Electrical Parts List	6-1
6-1 INDOOR MAIN PCB (DB92-02873A).....	6-1
6-2 OUTDOOR MAIN PBA(DB92-02866A)	6-5
6-3 ASSY WIFI PCB	6-11
7. Wiring Diagram	7-1
7-1 Indoor Unit.....	7-1
7-2 Outdoor Unit	7-2
7-3 ASSY WIFI KIT	7-3

Contents

8. PCB Diagram	8-1
8-1 Indoor Unit.....	8-1
8-2 Outdoor PCB	8-2
8-3 Wire connecting the indoor unit terminal blocks	8-8
9. Operating Instructions.....	9-1
9-1 Name of Each Part	9-1
9-2 Wireless Remote Control-Buttons and Display.....	9-2
10. Troubleshooting	10-1
10-1 Items to be checked first.....	10-1
10-2 Communication Error	10-2
10-3 PCB Inspection Method.....	10-37
10-4 ASSY WIFI KIT Inspection Method.....	10-39
11. Block Diagram	11-1
11-1 Indoor unit	11-1
11-2 Outdoor unit.....	11-2
12. Reference Sheet.....	12-1
12-1 Low Refrigerant Pressure Distribution.....	12-1
12-2 Pressure & Capacity mark.....	12-1
12-3 Q & A for Non-trouble.....	12-2
12-4 Cleaning /Filter Change.....	12-5
12-5 Installation.....	12-6
12-6 Installation Diagram of Indoor Unit and Outdoor Unit.....	12-7

1. Precautions

1-1 Installing the air conditioner

- **Users should not install the air conditioner by themselves.**
Ask the dealer or authorized company to install the air conditioner except window-type air conditioner in U.S.A and Canada.
- **If you don't install the air conditioner properly, it may cause a fire, a water leakage or an electric shock.**
- **You must install the air conditioner according to the national wiring regulations and safety regulations.**
- **Install the indoor unit higher than 2.5m from the floor to avoid the injury caused by the operation of the fan.**
(except the window-type air conditioner)
- **The manufacturer is not responsible for any accidents or injury caused by an incorrect installation.**
- **When installing the built-in type air conditioner, keep all electric cables such as the power cable and the connection cord in pipes, ducts, or cable channels to protect them from the danger of impact or any other incidents.**

1-2 Power supply and circuit breaker

- **If the power cord of the air conditioner is damaged, it must be replaced by the manufacturer or a qualified person in order to avoid a hazard.**
- **The air conditioner must be plugged into an independent circuit if applicable or connect the power cable to the auxiliary circuit breaker.**
An all pole disconnection form the power supply must be incorporated in the fixed wiring with a contact opening of >3mm.
- **Do not extend an electric cord to the air conditioner.**
- **The air conditioner must be plugged in after you complete the installation.**

1-3 During operation

- **Do not repair the air conditioner at your discretion.**
It is recommended to contact a service center directly.
- **Never spill any kind of liquid on the air conditioner.**
If this happens, turn off the air conditioner and contact an authorized service center.
- **Do not insert anything between the airflow blades to prevent damage of the inner fan and consequent injury.**
Keep children away from the air conditioner.
- **Do not place any obstacles in front of the air conditioner.**
- **Do not spray any kind of liquid into the indoor unit. If this happens, turn off the air conditioner and contact a service center.**
- **Make sure that the air conditioner is well ventilated at all times.**
Do not place a cloth or other materials over it.
- **Remove the batteries if you don't use the remote control for a long time. (If applicable)**
- **Use the remote control within 7 meters from the indoor unit. (If applicable)**

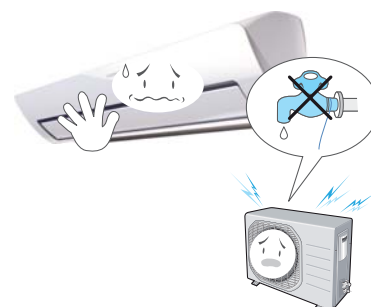

1-4 Disposing of the unit

- Before the throwing out the air conditioner, remove the batteries from the remote control.
- When you dispose of the air conditioner, consult your dealer. If pipes are removed incorrectly, refrigerant may blow out and cause air pollution. When it contacts with your skin, it can cause skin injury.
- The package of the air conditioner should be recycled or disposed of properly for environmental reasons.

1-5 Others

- Never store or load the air conditioner upside down or sideways to prevent the damage to the compressor.
- Young children or infirm persons should be always supervised when they use the air conditioner.
- Max current is measured according to IEC standard for safety.
- Current is measured according to ISO standard for energy efficiency.

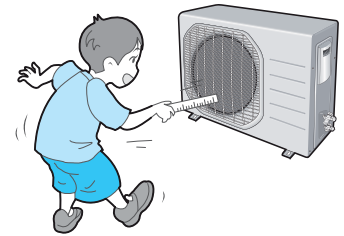

2. Product Specifications

2-1 The Feature of Product

- 2 step cooling
 - Get cool quickly and keep cool comfortably without shivering
- Single user mode
 - No worrying about the electricity bill, even using it when you're alone.
- Crystal gloss design
 - Uniquely stylish and innovative design to enhance your life and home
- Smart Wi-Fi
 - Control air conditioner anytime and anywhere
- Smart Installation
 - Get the confidence that it's perfectly installed
- Smart Installation
 - Get the confidence that it's perfectly installed
- Smart Check
 - Don't worry about the trouble-shooting in your home
- Triple Protector Plus
 - Use longer without damage in unsuitable conditions
- Easy Installation
 - Secure the easy Installation of Indoor unit and pipe connection
- Easy Filter
 - Quick and easy to clean filter saves time and effort

2-2 Product Specifications

ITEM			MODEL		AR09HSFNBWK/ET		AR12HSFNBWK/ET		AR09HSFSBWK/ZE		AR09HSFNBWK/ZE		AR12HSFSAWK/ZE	
					Indoor Unit	Outdoor Unit	Indoor Unit	Outdoor Unit	Indoor Unit	Outdoor Unit	Indoor Unit	Outdoor Unit	Indoor Unit	Outdoor Unit
Type			Wall-mounted		Wall-mounted		Wall-mounted		Wall-mounted		Wall-mounted		Wall-mounted	
Performance	Capacity	Cooling	KW	1.3/3.5/4.0		1.3/3.5/4.0		1.3/3.5/4.0		1.3/3.5/4.0		1.3/3.5/4.0		
		Heating	(Low/Std/Max)	0.95/4.0/5.1		0.95/4.0/5.1		0.95/4.0/5.1		0.95/4.0/5.1		0.95/4.0/5.1		
	Running Frequency	Cooling	Hz	25/71/81		25/71/81		25/71/81		25/71/81		25/71/81		
		Heating	(Low/Std/Max)	25/78/100		25/78/100		25/78/100		25/78/100		25/78/100		
	Noise	声压	dB	43	53	43	53	43	53	43	53	43	53	
		声功率	(H/L)	56	62	56	62	56	62	56	62	56	62	
Energy Efficiency Ratio	Cooling	W/W	3.4		3.4		3.4		3.4		3.4			
	Heating	(Std)	3.64		3.64		3.64		3.64		3.64			
Power		ph-V-Hz	1phase, 220-240V~, 50Hz		1phase, 220-240V~, 50Hz		1phase, 220-240V~, 50Hz		1phase, 220-240V~, 50Hz		1phase, 220-240V~, 50Hz			
Pow	Power Consumption	Cooling	KW	0.31/1.03/1.21		0.31/1.03/1.21		0.31/1.03/1.21		0.31/1.03/1.21		0.31/1.03/1.21		
		Heating	(Low/Std/Max)	0.25/1.10/1.46		0.25/1.10/1.46		0.25/1.10/1.46		0.25/1.10/1.46		0.25/1.10/1.46		
	Operating Current	Cooling	A	2.1/5.0/6.0		2.1/5.0/6.0		2.1/5.0/6.0		2.1/5.0/6.0		2.1/5.0/6.0		
		Heating	(Low/Std/Max)	2.1/5.0/6.0		2.1/5.0/6.0		2.1/5.0/6.0		2.1/5.0/6.0		2.1/5.0/6.0		
Power Factor	Cooling	%	70/85/90		70/85/90		70/85/90		70/85/90		70/85/90			
	Heating	(Low/Std/Max)	70/85/90		70/85/90		70/85/90		70/85/90		70/85/90			
Size	Gross Dimension	W*D*H	mm	886*317*335	844*622*353	886*317*335	844*622*353	886*317*335	844*622*353	886*317*335	844*622*353	886*317*335	844*622*353	
	Weight(Net)		kg	9.5	29.5	9.5	29.5	9.5	29.5	9.5	29.5	9.5	29.5	
	Refrigerant Pipe	Liquid	mm	6.35 (1/4 inch)		6.35 (1/4 inch)		6.35 (1/4 inch)		6.35 (1/4 inch)		6.35 (1/4 inch)		
		Gas	mm	9.52 (3/8 inch)		9.52 (3/8 inch)		9.52 (3/8 inch)		9.52 (3/8 inch)		9.52 (3/8 inch)		
	Drain Hose		L*D	550±20		550±20		550±20		550±20		550±20		
	Compressor	Type		UG9A090FUAER		UG9A090FUAER		UG9A090FUAER		UG9A090FUAER		UG9A090FUAER		
		Motor	Type	HERMETIC		HERMETIC		HERMETIC		HERMETIC		HERMETIC		
			Rated Output(W)	-		-		-		-		-		
	Oil Type			-		-		-		-		-		
	Blower	Type		CROSS-FLOW	PROPELLER	CROSS-FLOW	PROPELLER	CROSS-FLOW	PROPELLER	CROSS-FLOW	PROPELLER	CROSS-FLOW	PROPELLER	
motor		Type	BLDC	BLDC	BLDC	BLDC	BLDC	BLDC	BLDC	BLDC	BLDC	BLDC		
Heat Exchanger			2ROWx14STEPx635, 2-2pass	1ROWx47STEPx684mm	2ROWx14STEPx635, 2-2pass	1ROWx47STEPx684mm	2ROWx14STEPx635, 2-2pass	1ROWx47STEPx684mm	2ROWx14STEPx635, 2-2pass	1ROWx47STEPx684mm	2ROWx14STEPx635, 2-2pass	1ROWx47STEPx684mm		
Refrigerant Control Unit			R410		R410		R410		R410		R410			
Freezer Oil Capacity		cc	-		-		-		-		-			
Refrigerant to Change(R410A)		g	950		950		950		950		950			
Proterction Device(OLP)			NONE		NONE		NONE		NONE		NONE			
Operation condition range	Cooling		-10℃~46℃		-10℃~46℃		-10℃~46℃		-10℃~46℃		-10℃~46℃			
	Heating		-15℃~24℃		-15℃~24℃		-15℃~24℃		-15℃~24℃		-15℃~24℃			











2-2 Product Specifications

ITEM				MODEL		AR12HSFNBWK/ZE		AR12HSFSRWK/ER		AR12HSFNRWK/ER		AR09HSSDRWK/ER		AR09HSFSBWK/ET	
				Indoor Unit	Outdoor Unit	Indoor Unit	Outdoor Unit	Indoor Unit	Outdoor Unit	Indoor Unit	Outdoor Unit	Indoor Unit	Outdoor Unit	Indoor Unit	Outdoor Unit
Type				Wall-mounted	Wall-mounted	Wall-mounted	Wall-mounted	Wall-mounted	Wall-mounted	Wall-mounted	Wall-mounted	Wall-mounted	Wall-mounted	Wall-mounted	Wall-mounted
Performance	Capacity	Cooling	KW	1.3/3.5/4.0		1.3/3.5/4.0		1.3/3.5/4.0		1.3/2.5/3.3		1.3/2.5/3.3			
		Heating	(Low/Std/Max)	0.95/4.0/5.1		0.95/4.0/5.1		0.95/4.0/5.1		0.95/3.2/4.7		0.95/3.3/4.7			
	Running Frequency	Cooling	Hz	25/71/81		25/71/81		25/71/81		25/47/65		25/51/65			
		Heating	(Low/Std/Max)	25/78/100		25/78/100		25/78/100		25/63/93		25/65/93			
	Noise	声压	dB	43	53	43	53	43	53	41	54	41	54		
		声功率	(H/L)	56	62	56	62	56	62	51	59	51	59		
	Energy Efficiency Ratio	Cooling	W/W	3.4		3.4		3.4		4.1		3.73			
Heating		(Std)	3.64		3.64		3.64		4.1		3.63				
Power		ph-V-Hz	1phase, 220-240V~, 50Hz		1phase, 220-240V~, 50Hz		1phase, 220-240V~, 50Hz		1phase, 220-240V~, 50Hz		1phase, 220-240V~, 50Hz				
Pow	Power Consumption	Cooling	KW	0.31/1.03/1.21		0.31/1.03/1.21		0.31/1.03/1.21		0.31/0.61/0.93		0.31/0.67/0.93			
		Heating	(Low/Std/Max)	0.25/1.10/1.46		0.25/1.10/1.46		0.25/1.10/1.46		0.25/0.78/1.4		0.25/0.91/1.4			
	Operating Current	Cooling	A	2.1/5.0/6.0		2.1/5.0/6.0		2.1/5.0/6.0		2.1/3.6/4.5		2.1/3.6/4.5			
		Heating	(Low/Std/Max)	2.1/5.0/6.0		2.1/5.0/6.0		2.1/5.0/6.0		1.7/4.6/6.8		1.7/4.4/6.8			
Power Factor	Cooling	%	70/85/90		70/85/90		70/85/90		70/85/90		70/85/90				
	Heating	(Low/Std/Max)	70/85/90		70/85/90		70/85/90		70/85/90		70/85/90				
Size	Gross Dimension	W*D*H	mm	886*317*335	844*622*353	886*317*335	844*622*353	886*317*335	844*622*353	886*317*335	844*622*353	886*317*335	844*622*353		
	Weight(Net)		kg	9.5	29.5	9.5	29.5	9.5	29.5	9.5	29.5	9.5	29.5		
	Refrigerant Pipe	Liquid	mm	6.35 (1/4 inch)		6.35 (1/4 inch)		6.35 (1/4 inch)		6.35 (1/4 inch)		6.35 (1/4 inch)			
		Gas	mm	9.52 (3/8 inch)		9.52 (3/8 inch)		9.52 (3/8 inch)		9.52 (3/8 inch)		9.52 (3/8 inch)			
	Drain Hose		L*D	550±20		550±20		550±20		550±20		550±20			
	Compressor	Type		UG9A090FUAER		UG9A090FUAER		UG9A090FUAER		UG9A090FUAER		UG9A090FUAER			
		Motor	Type	HERMETIC		HERMETIC		HERMETIC		HERMETIC		HERMETIC			
			Rated Output(W)	-		-		-		-		-			
	Oil Type			-		-		-		-		-			
	Blower	Type		CROSS-FLOW	PROPELLER	CROSS-FLOW	PROPELLER	CROSS-FLOW	PROPELLER	CROSS-FLOW	PROPELLER	CROSS-FLOW	PROPELLER		
motor		Type	BLDC	BLDC	BLDC	BLDC	BLDC	BLDC	BLDC	BLDC	BLDC	BLDC			
Heat Exchanger			2ROWx14STEPx635, 2-2pass	1ROWx47STEPx684mm	2ROWx14STEPx635, 2-2pass	1ROWx47STEPx684mm	2ROWx14STEPx635, 2-2pass	1ROWx47STEPx684mm	2ROWx14STEPx635, 2-2pass	1ROWx47STEPx684mm	2ROWx14STEPx635, 2-2pass	1ROWx47STEPx684mm			
Refrigerant Control Unit			R410		R410		R410		R410		R410				
Freezer Oil Capacity		cc	-		-		-		-		-				
Refrigerant to Change(R410A)		g	950		950		950		950		950				
Protection Device(OLP)			NONE		NONE		NONE		NONE		NONE				
Operation condition range	Cooling		-10℃~46℃		-10℃~46℃		-10℃~46℃		-10℃~46℃		-10℃~46℃				
	Heating		-15℃~24℃		-15℃~24℃		-15℃~24℃		-15℃~24℃		-15℃~24℃				











2-2 Product Specifications

ITEM		MODEL		AR09,12HSFNCWK/ET		AR09,12HSFSBUR/ET		AR09,12HSFNCWK/ZE		AR09,12HSFSBUR/ZE	
		Indoor Unit	Outdoor Unit	Indoor Unit	Outdoor Unit	Indoor Unit	Outdoor Unit	Indoor Unit	Outdoor Unit		
Type		Wall-mounted		Wall-mounted		Wall-mounted		Wall-mounted		Wall-mounted	
Performance	Capacity	Cooling	KW	1.3/3.5/4.0		1.3/3.5/4.0		1.3/3.5/4.0		1.3/2.5/3.3	
		Heating	(Low/Std/Max)	0.95/4.0/5.1		0.95/4.0/5.1		0.95/4.0/5.1		0.95/3.2/4.7	
	Running Frequency	Cooling	Hz	25/71/81		25/71/81		25/71/81		25/47/65	
		Heating	(Low/Std/Max)	25/78/100		25/78/100		25/78/100		25/63/93	
	Noise	声压	dB	43	53	43	53	43	53	41	54
		声功率	(H/L)	56	62	56	62	56	62	51	59
	Energy Efficiency Ratio	Cooling	W/W	3.4		3.4		3.4		4.1	
Heating		(Std)	3.64		3.64		3.64		4.1		
Power		ph-V-Hz	1phase, 220-240V~, 50Hz		1phase, 220-240V~, 50Hz		1phase, 220-240V~, 50Hz		1phase, 220-240V~, 50Hz		
Pow	Power Consumption	Cooling	KW	0.31/1.03/1.21		0.31/1.03/1.21		0.31/1.03/1.21		0.31/.61/0.93	
		Heating	(Low/Std/Max)	0.25/1.10/1.46		0.25/1.10/1.46		0.25/1.10/1.46		0.25/0.78/1.4	
	Operating Current	Cooling	A	2.1/5.0/6.0		2.1/5.0/6.0		2.1/5.0/6.0		2.1/3.6/4.5	
		Heating	(Low/Std/Max)	2.1/5.0/6.0		2.1/5.0/6.0		2.1/5.0/6.0		1.7/4.6/6.8	
Power Factor	Cooling	%	70/85/90		70/85/90		70/85/90		70/85/90		
	Heating	(Low/Std/Max)	70/85/90		70/85/90		70/85/90		70/85/90		
Size	Gross Dimension	W*D*H	mm	886*317*335	844*622*353	886*317*335	844*622*353	886*317*335	844*622*353	886*317*335	844*622*353
	Weight(Net)		kg	9.5	29.5	9.5	29.5	9.5	29.5	9.5	29.5
	Refrigerant Pipe	Liquid	mm	6.35 (1/4 inch)		6.35 (1/4 inch)		6.35 (1/4 inch)		6.35 (1/4 inch)	
		Gas	mm	9.52 (3/8 inch)		9.52 (3/8 inch)		9.52 (3/8 inch)		9.52 (3/8 inch)	
	Drain Hose		L*D	550±20		550±20		550±20		550±20	
	Compressor	Type		UG9A090FUAER		UG9A090FUAER		UG9A090FUAER		UG9A090FUAER	
		Motor	Type	HERMETIC		HERMETIC		HERMETIC		HERMETIC	
			Rated Output(W)	-		-		-		-	
	Oil Type			-		-		-		-	
	Blower	Type		CROSS-FLOW	PROPELLER	CROSS-FLOW	PROPELLER	CROSS-FLOW	PROPELLER	CROSS-FLOW	PROPELLER
motor		Type	BLDC	BLDC	BLDC	BLDC	BLDC	BLDC	BLDC	BLDC	
Heat Exchanger			2ROWx14STEPx635, 2-2pass	1ROWx47STEPx684mm	2ROWx14STEPx635, 2-2pass	1ROWx47STEPx684mm	2ROWx14STEPx635, 2-2pass	1ROWx47STEPx684mm	2ROWx14STEPx635, 2-2pass	1ROWx47STEPx684mm	
Refrigerant Control Unit			R410		R410		R410		R410		
Freezer Oil Capacity		cc	-		-		-		-		
Refrigerant to Change(R410A)		g	950		950		950		950		
Proterction Device(OLP)			NONE		NONE		NONE		NONE		
Operation condition range	Cooling		-10℃~46℃		-10℃~46℃		-10℃~46℃		-10℃~46℃		
	Heating		-15℃~24℃		-15℃~24℃		-15℃~24℃		-15℃~24℃		









2-3 The Comparative Specifications of Product

ITEM		MODEL	Develop Model				
		AR09HSFNBWK/ET	AR12HSFNBWK/ET	AR09HSFSBWK/ZE	AR09HSFNBWK/ZE	AR12HSFSAWK/ZE	
Design	Indoor Unit						
	Outdoor Unit						
Net Weight	Indoor Unit	9.5	9.5	9.5	9.5	9.5	
	Outdoor Unit	29.5	29.5	29.5	29.5	29.5	
Outer Dimension	Indoor Unit	886*317*335	886*317*335	886*317*335	886*317*335	886*317*335	
	Outdoor Unit	844*622*353	844*622*353	844*622*353	844*622*353	844*622*353	
Noise	Indoor Unit	43(Sound Pressure)/56(Sound Power)	43(Sound Pressure)/56(Sound Power)	43(Sound Pressure)/56(Sound Power)	43(Sound Pressure)/56(Sound Power)	43(Sound Pressure)/56(Sound Power)	
	Outdoor Unit	53/(Sound Pressure)/62(Sound Power)	53/(Sound Pressure)/62(Sound Power)	53/(Sound Pressure)/62(Sound Power)	53/(Sound Pressure)/62(Sound Power)	53/(Sound Pressure)/62(Sound Power)	
Air Purifying System	Filter	FULL HDFILTER	FULL HDFILTER	FULL HDFILTER	FULL HDFILTER	FULL HDFILTER	

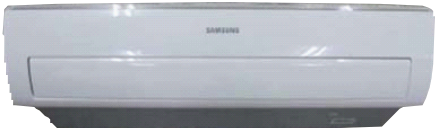







2-3 The Comparative Specifications of Product

ITEM	MODEL	Develop Model				
		AR12HSFNBWK/ZE	AR12HSFSRWK/ER	AR12HSFNRWK/ER	AR09HSSDRWK/ER	AR09HSFSBWK/ET
Design	Indoor Unit					
	Outdoor Unit					
Net Weight	Indoor Unit	9.5	9.5	9.5	9.5	9.5
	Outdoor Unit	29.5	29.5	29.5	29.5	29.5
Outer Dimension	Indoor Unit	886*317*335	886*317*335	886*317*335	886*317*335	886*317*335
	Outdoor Unit	844*622*353	844*622*353	844*622*353	844*622*353	844*622*353
Noise	Indoor Unit	43(Sound Pressure)/56(Sound Power)	43(Sound Pressure)/56(Sound Power)	43(Sound Pressure)/56(Sound Power)	41(Sound Pressure)/54(Sound Power)	41(Sound Pressure)/54(Sound Power)
	Outdoor Unit	53/(Sound Pressure)/62(Sound Power)	53/(Sound Pressure)/62(Sound Power)	53/(Sound Pressure)/62(Sound Power)	51(Sound Pressure)/59(Sound Power)	51(Sound Pressure)/59(Sound Power)
Air Purifying System	Filter	FULL HDFILTER	FULL HDFILTER	FULL HDFILTER	FULL HDFILTER	FULL HDFILTER

2-3 The Comparative Specifications of Product

ITEM		MODEL	Develop Model			
		AR09,12HSFNCWK/ET	AR09,12HSFSBUR/ET	AR09,12HSFNCWK/ZE	AR09,12HSFSBUR/ZE	
Design	Indoor Unit					
	Outdoor Unit					
Net Weight	Indoor Unit	9.5	9.5	9.5	9.5	
	Outdoor Unit	29.5	29.5	29.5	29.5	
Outer Dimension	Indoor Unit	886*317*335	886*317*335	886*317*335	886*317*335	
	Outdoor Unit	844*622*353	844*622*353	844*622*353	844*622*353	
Noise	Indoor Unit	43(Sound Pressure)/56(Sound Power)	43(Sound Pressure)/56(Sound Power)	43(Sound Pressure)/56(Sound Power)	41(Sound Pressure)/54(Sound Power)	
	Outdoor Unit	53/(Sound Pressure)/62(Sound Power)	53/(Sound Pressure)/62(Sound Power)	53/(Sound Pressure)/62(Sound Power)	51(Sound Pressure)/59(Sound Power)	
Air Purifying System	Filter	FULL HDFILTER	FULL HDFILTER	FULL HDFILTER	FULL HDFILTER	

2-4 Accessory and Option Specifications

Item	Descriptions	Code-No.	Q'TY	Remark
	Installation Plate **12*(03 frame)	DB90-07732A	1	Indoor unit case
	Remote controller **12*(03 frame)	DB93-14195A	1	
	Batteries for Remote controller	4301-000121	2	
	User' s & Installation Manual **12*(03 frame)	DB68-04208A DB68-04211A DB68-04212A	1	
	Wi-Fi Manual **12*(03 frame)	DB68-04209A DB68-04215A	1	
	M4x10 Tapped Screws	DB97-23032A	2	
	M4 x 16 Tapped Screws	DB97-11984A	2	
	Drain Plug	DB67-20011A	1	Outdoor unit case
	Rubber Leg	DB73-20134A	4	

3. Alignment and Adjustments

3-1 Test Mode

■ How to Approach Test Mode

You can approach the test mode by pressing the on/off switch of indoor unit for 5 seconds.



■ Test mode operation option

After installing the air conditioner, check whether each subordinate is normally operated or not by operating the test mode.

- **When an Error occurs, display the Error Mode.**
- **Operation Mode :** Cool mode. operate the cool mode by operating the compressor by force without the compressor ON/OFF according to the set temperature/indoor temperature. (Do not follow the antifreeze control)
- **Up-down louver :** Up-down swing mode
- **Indoor Fan :** Turbo



Note

- Because the test mode operates the cool mode by force not related to the set temperature / indoor temperature, check whether each subordinate is operated normally or not after completing installation and must turn off the power of the air conditioner.

3-2 Display Error and Check Method

3-2-1 Indoor Display Error and Check Method

ERROR MODE	DESCRIPTION
E101 / E102	Communication Error (Indoor Outdoor)
E121	ROOM TH sensor error
E122	INDOOR MID, INDOOR IN PIPE-TH sensor error
E154	Fan Error (Indoor)
E162	EEPROM Error (Indoor)
E163	Option Error
E203	Time out Comm. (Inv Micom ↔ Main Micom)
E221	OUT-TH(Outdoor Temperature) Sensor Error
E231	CON-TH(Cond Temperature) Sensor Error
E251	DIS-TH(Discharge Temperature) Sensor Error
E416	DIS-TH(Discharge Temperature) Over Error
E422	EEV or Valve Close error-Self diagnosis
E440	Prohibit Operation Condition Error (Heating)
E441	Prohibit Operation Condition Error (Cooling)
E458	Fan Error(Outdoor)
E461	Comp Starting Error
E462	AC Input I_Limit Trip Error
E464	IPM Over Current(O.C) Error
E465	Comp V_limit/I_limit Error
E466	DC-Link Voltage Under/Over Error
E467	Comp Wire Missing Error
E468	Current Sensor Error
E469	DC-Link Voltage Sensor Error
E470	EEPROM Data Error (no data)
E471	EEPROM Data Error (Main Micom ↔ Inv Micom)
E474	Heatsink Sensor Error
E483	Over Voltage Protection Error
E484	PFC Over Load Error
E485	Input Current Sensor Error
E488	AC Input Voltage Sensor Error
E500	Heatsink Over Temperature Error
E554	Gas Leak Error

7-SEG	ERROR MODE			DESCRIPTION
	LED1 OPERATION	LED2 TIMER	LED3 OPTION	
E101, E102	○	●	●	Communication error (indoor ↔ outdoor)
E121	○	●	○	ROOM TH sensor error
E122, E123	●	●	○	INDOOR MID, INDOOR IN PIPE-TH sensor error
E154	○	○	●	Fan error(indoor)
E162	●	●	●	EEPROM error
E163	●	●	●	Option error
FROM E200	●	○	●	Outdoor error display
E422	●	○	●	EEV or Valve Close error-Self diagnosis

● : LAMP ON ○ : LAMP OFF ● (with dot) : LAMP BLINK

* Note *

If the Set doesn't work (No power), check the Thermal fuse of Terminal block OPEN or SHORT with Multimeter.

* Measure the Thermal fuse housing PIN#1 ~ 2 :
OPEN(disconnection) -> defective product

Outdoor LED Display Error and Check Method (12K/18K/24K)

LED PATTERN			DESCRIPTION
YEL	GRN	RED	
○	○	○	Power off/VDD NG
●	●	●	Power ON reset(1sec)
○	◉	●	Normal Operation
○	○	●	Abnormal Communication (Indoor↔Outdoor)
○	●	●	
○	○	◉	IPM Over Current (O.C) Error
○	◉	○	Comp Starting Error
○	●	○	EEPROM Data Error (no data)
○	●	◉	DC-Link Voltage Under/Over Error
			PFC Over Load Error
			Over Voltage Protection Error
◉	○	◉	OUT-TH(Outdoor Temperature) Sensor Error
◉	○	●	DIS-TH(Discharge Temperature) Over Error
◉	◉	○	DIS-TH(Discharge Temperature) Sensor Error
◉	◉	●	Current Sensor Error
			Heatsink Sensor Error
			Input Current Sensor Error
◉	●	○	Comp V_limit/I_limit Error
			Heatsink Over Temperature Error
◉	●	◉	CON-TH(Cond Temperature) Sensor Error
◉	●	●	Time out Comm. (Inv Micom↔Main Micom)
●	○	○	Fan Error(Outdoor)
●	○	◉	EEPROM Data Error (Main Micom↔Inv Micom)
●	○	●	Comp Wire Missing Error
●	◉	○	Prohibit Operation Condition Error (Heating)
			Prohibit Operation Condition Error (Cooling)
●	◉	◉	DC-Link Voltage Sensor Error
			AC Input Voltage Sensor Error
●	◉	●	AC Input I_Limit Trip Error
●	●	○	Gas Leak Error
			EEV or Valve Close error-Self diagnosis
○	◉	◉	Test Operation at Cooling Mode
◉	◉	◉	Test Operation at Heating Mode

● LED ON, ○ LED OFF, ◉ LED BLINKING

3-3 Setting Option Setup Method

ex) Option No. :

Note :



SEG1, SEG7, SEG13, SEG19 need not to be pressed in, so in fact the Option No. we should press in is as below.

30 00 07 C2 6C 83 10 00 00 00 20 00 00 00 00 00 00 10 00 00

SEG1	SEG2	SEG3	SEG4	SEG5	SEG6	SEG7	SEG8	SEG9	SEG10	SEG11	SEG12	SEG13	SEG14	SEG15	SEG16	SEG17	SEG18	SEG19	SEG20	SEG21	SEG22	SEG23	SEG24
0	3	0	0	0	0	1	7	C	2	6	C	2	8	3	1	0	3	0	0	0	0	0	0
SEG25	SEG26	SEG27	SEG28	SEG29	SEG30	SEG31	SEG32	SEG33	SEG34	SEG35	SEG36	SEG37	SEG38	SEG39	SEG40	SEG41	SEG42	SEG43	SEG44	SEG45	SEG46	SEG47	SEG48
0	2	0	0	0	0	1	0	0	0	0	0	2	0	0	0	0	1	3	0	0	0	0	0

Step 1





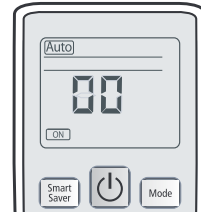





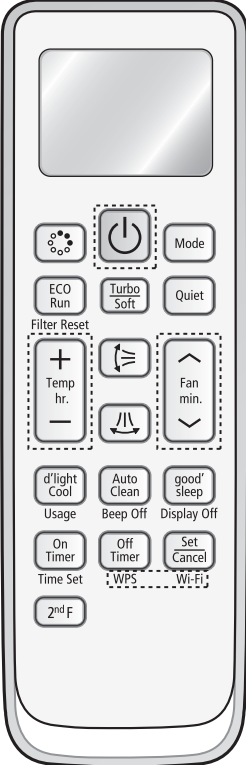















Enter the Option Setup mode.











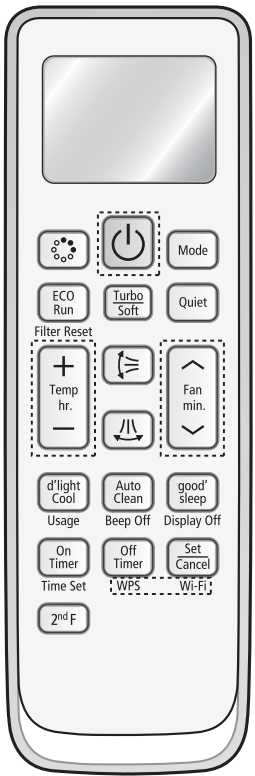

















1. Tack out the batteries of remote control.
2. Press the temperature  button simultaneously and insert the battery again.
3. Make sure the remote control display shown as .



Step 2

Enter the Options Setup mode and select your options according to the following procedure.

	Feature	Display
	<p>1 The default value is .</p> <p>Every time you push the  button, the display panel reads  Auto ⇒ Cool ⇒ Dry ⇒ Fan ⇒ Heat,  Auto ⇒ Cool ⇒ Dry ⇒ Fan ⇒ Heat repeatedly.</p>	
	<p>2 Push the  button to set the display panel to 3.</p> <p>Every time you push the  button, the display panel reads 0→1→2→3→.....→9→A→b→c→d→E→F repeatedly.</p>	
	<p>3 Push the  button to .</p> <p>Every time you push the  button, the display panel reads 0→1→2→3→.....→9→A→b→c→d→E→F repeatedly.</p>	
	<p>4 Push the  button to .</p> <p>Push the  button to set the display panel to 7.</p> <p>Every time you push the  button, the display panel reads 0→1→2→3→.....→9→A→b→c→d→E→F repeatedly.</p>	
	<p>5 Push the  button to .</p> <p>Push the  button to set the display panel to C.</p> <p>Every time you push the  button, the display panel reads 0→1→2→3→.....→9→A→b→c→d→E→F repeatedly.</p>	
	<p>6 Push the  button to set the display panel to 2.</p> <p>Every time you push the  button, the display panel reads 0→1→2→3→.....→9→A→b→c→d→E→F repeatedly.</p>	

	Feature	Display
	<p>7 Push the  button to  . Push the  button to set the display panel to 6. Every time you push the  button, the display panel reads 0→1→2→3→.....→9→A→b→c→d→E→F repeatedly.</p>	
	<p>8 Push the  button to set the display panel to 8. Every time you push the  button, the display panel reads 0→1→2→3→.....→9→A→b→c→d→E→F repeatedly.</p>	
	<p>9 Push the  button to  . Push the  button to set the display panel to 8. Every time you push the  button, the display panel reads 0→1→2→3→.....→9→A→b→c→d→E→F repeatedly.</p>	
	<p>10 Push the  button to set the display panel to 3. Every time you push the  button, the display panel reads 0→1→2→3→.....→9→A→b→c→d→E→F repeatedly.</p>	
	<p>11 Push the  button to  . Push the  button to set the display panel to 1. Every time you push the  button, the display panel reads 0→1→2→3→.....→9→A→b→c→d→E→F repeatedly.</p>	
	<p>12 Push the  button to  .</p>	
	<p>13 Push the  button to  .</p>	
	<p>14 Push the  button to  .</p>	

Step 3 Upon completion of the selection, check you made right selections.

Press the Mode (Mode) Selection key to set the display part and check the display part.
→ The display part shows like below when each time you press Mode button.



































Step 4 Pressing the ON/OFF button (ON/OFF).

When pressing the operation ON/OFF key with the direction of remote control for unit, the sound "Ding" or "Diriring" is heard and the OPERATION ICON(≡) lamp of the display is flickering at the same time, then the input of option is completed.
(If the deriving sound isn't heard, try again pressing the ON/OFF button.)

Step 5

Enter the Options Setup mode and select your options according to the following procedure.

	Feature	Display
	<p>1 Step 1 (Enter the Option Setup mode) is executed. (Seg25 ~ 48 for setting remote control Setup)</p>	
	<p>2 Push the  Mode button to set the display panel to 2. Every time you push the  button, the display panel reads 0-1-2 → 3 → ... 9 → A → b → c → d → E → F repeatedly.</p>	
	<p>3 Push the  button to </p>	
	<p>4 Push the  button to </p>	
	<p>5 Push the  button to </p>	
	<p>6 Push the  button to </p>	
	<p>7 Push the  button to </p>	
	<p>8 Push the  button to </p>	
	<p>9 Push the  button to </p>	
	<p>10 Push the  Mode button to set the display panel to 1. Every time you push the  button, the display panel reads 0-1-2 → 3 → ... 9 → A → b → c → d → E → F repeatedly.</p>	
	<p>11 Push the  button to </p>	
	<p>12 Push the  button to </p>	

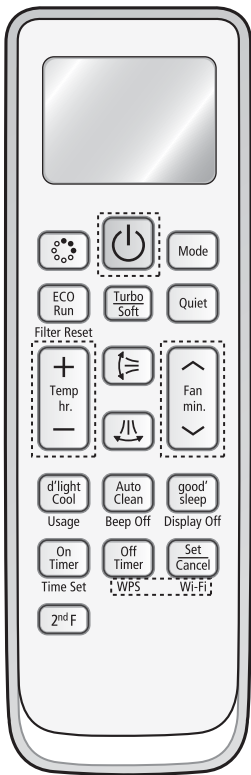

Step 6 Upon completion of the selection, check you made right selections.

Press the Mode  Selection key to set the display part and check the display part.
 → The display part shows like below when each time you press Mode button.

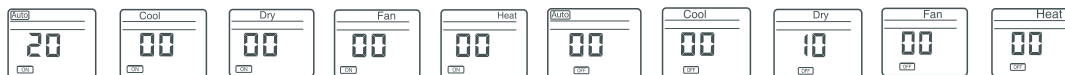

Step 7 Pressing the ON/OFF button ) .

When pressing the operation ON/OFF key with the direction of remote control for unit, the sound ' ' Ding' ' or ' ' Diriring' ' is heard and the OPERATION ICON (≡) lamp of the display is flickering at the same time, then the input of option is completed. (If the deriving sound isn' t heard, try again pressing the ON/OFF button.)

Step 8 Unit operation test-run.

- First: Remove the battery from the remote control.
- Second : Re-insert the battery into the remote control.
- Third : Press ON/OFF key with the direction of remote control for set.

■ Error mode

1. If all lamps of indoor unit are flickering, Plug out, plug in power plug again and press ON/OFF key to retry.
2. If the unit is not working properly or all lamps are continuously flickering after setting the option code, see if the correct option code is set up for its model.

□ Option Items

Model	1-6	7-12	13-18	19-24	25-30	31-36	37-42	43-48
AR09HSFNBWK/ET	010005	156A15	271921	372534	034040	103341	200000	300000
AR12HSFNBWK/ET	010005	156A37	272328	372534	034746	10474E	200000	300000
AR09HSFSBWK/ZE	010005	156A15	271921	372534	034040	103341	200000	300000
AR09HSFNBWK/ZE	010005	156A15	271921	372534	034040	103341	200000	300000
AR12HSFSAWK/ZE	010005	156A37	272328	372534	034746	10474E	200000	300000
AR12HSFNBWK/ZE	010005	156A37	272328	372534	034746	10474E	200000	300000
AR12HSFSRWK/ER	010005	156A37	272328	372534	034746	10474E	200000	300000
AR12HSFNWK/ER	010005	156A37	272328	372534	034746	10474E	200000	300000
AR09HSSDRWK/ER	011345	156215	271920	372514	033D3E	102F3F	200000	300000
AR09HSFSBWK/ET	010005	156A15	271921	372534	034040	103341	200000	300000

Model	1-6	7-12	13-18	19-24	25-30	31-36	37-42	43-48
AR09HSFSBURNZE	010005	15621B	271921	372704	034040	103341	200000	300000
AR12HSFSBURNZE	010005	15623B	272328	372704	034746	10474E	200000	300000
AR09HSFNCWKZE	010005	15621B	271921	372704	034040	103341	200000	300000
AR12HSFNCWKZE	010005	15623B	272328	372704	034746	10474E	200000	300000
AR09HSFSBURNET	010005	15621B	271921	372704	034040	103341	200000	300000
AR12HSFSBURNET	010005	15623B	272328	372704	034746	10474E	200000	300000
AR09HSFNCWKNET	010005	15621B	271921	372704	034040	103341	200000	300000
AR12HSFNCWKNET	010005	15623B	272328	372704	034746	10474E	200000	300000

3-4 EEPROM Download (485 communication model)

Method#1 : Using Communication line

1) Power off

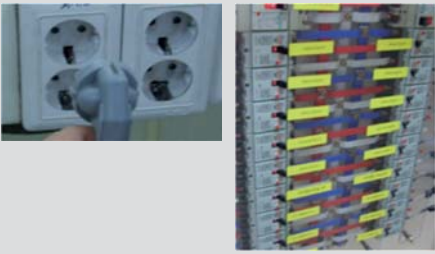

2) Take off the side cover



3) Connect PC-Download Jig-PBA

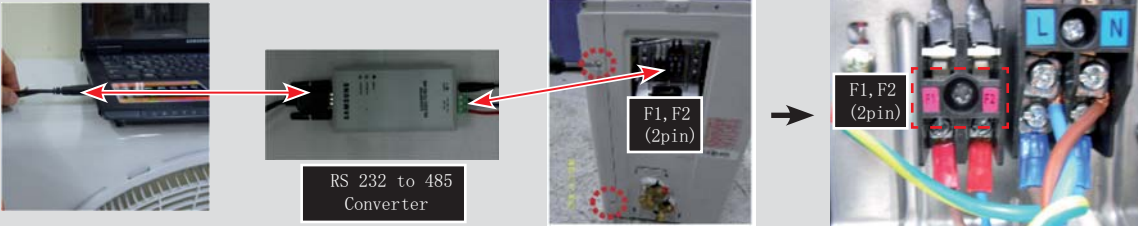

4) Execute the Inverter Download program



5) Select COM Port and connect



6) Open the file (*.src)

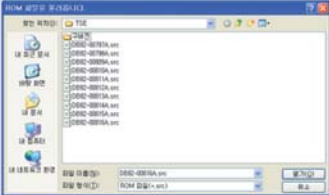

7) Click the Start button and reset the power

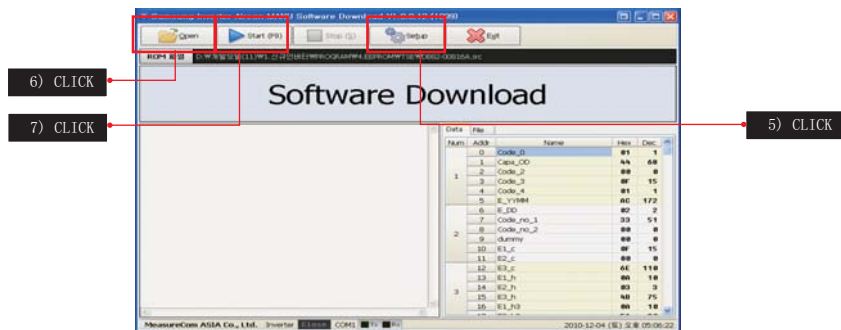
Main	Addr	Name	Hex	Dec
0	00h_0h		01	1
1	00h_01h		A4	68
2	00h_02h		00	0
3	00h_03h		0F	15
4	00h_04h		01	1
5	00h_05h		40	172
6	00h_06h		02	2
7	00h_07h		33	51
8	00h_08h		00	0
9	00h_09h		00	0
10	00h_0Ah		00	0
11	00h_0Bh		00	0
12	00h_0Ch		4E	118
13	00h_0Dh		00	0
14	00h_0Eh		00	0
15	00h_0Fh		40	75
16	00h_10h		00	0

Method#2 : Using Serial line

1) Power off

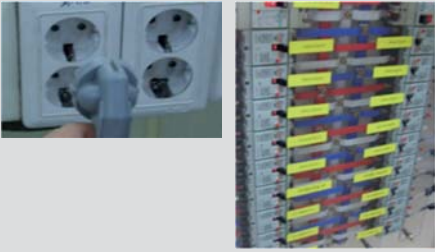

2) Take off the Cabinet : Check the LED off



3) Connect PC-Download Jig-PBA



Download connector (10pin, Black)

- 1) DB41-01010A : CN201
- 2) DB41-01129A : CN201
- 3) DB41-01023A : CN512
- 4) DB41-01081B : CN37

PIN# 1:RXD, 2:TXD, 9:GND, 10:VCC

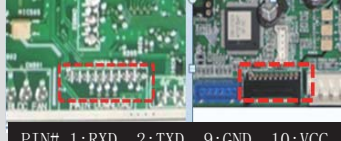

Download connector (20pin, Black)

- 1) DB41-01227A : CN201
- 2) DB41-01228A : CN201

PIN# 1:RXD, 2:TXD, 9:GND, 10:VCC

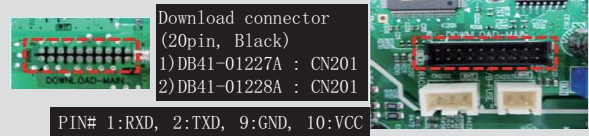

4) Execute the Inverter Download program



5) Select COM Port and connect

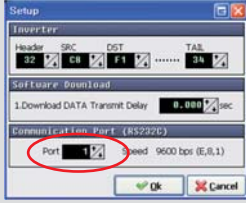

6) Open the file(*.src)

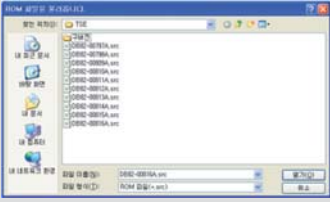

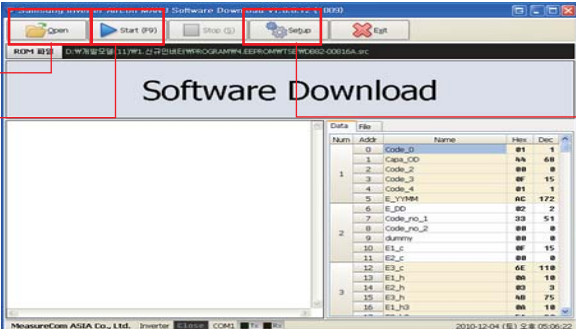

7) Click the Start button





Num	Addr	Name	Hrs	Dec
0	Code_0		01	1
1	Code_1	Capa_CD	0A	68
2	Code_2		0B	8
3	Code_3		0F	15
4	Code_4		01	1
5	E_VVHst		0C	172
6	E_EP0		02	2
7	Code_no_1		33	51
8	Code_no_2		00	8
9	dummy		00	8
10	ET_c		0F	15
11	ET_c		00	8
12	ET_c		4E	110
13	ET_h		00	10
14	ET_h		00	3
15	ET_h		0B	75
16	ET_h		00	10









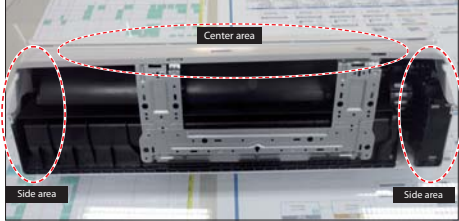

4. Disassembly and Reassembly



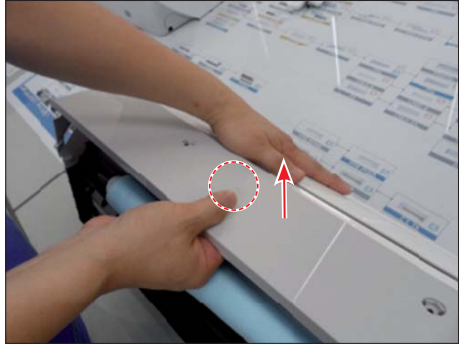

■ Necessary Tools

Item	Remark
+SCREW DRIVER	
MONKEY SPANNER	
-SCREW DRIVER	

4-1. Indoor Unit

No	Parts	Procedure	Remark
1	PANEL-FRONT	<p>1) Stop the driving of air conditioner and shut off main power supply.</p> <p>2) Detach FILTER PRE from the PANEL FRONT.</p> <p>3) Cover Panel is assembled on bottom of indoor unit as shown in the figure. Remove the Cap Screw as shown on the right side and then remove the screw and separate the Cover Panel.</p>	   

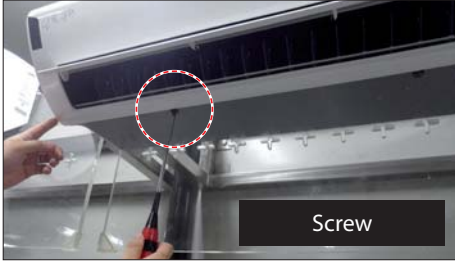
No	Parts	Procedure	Remark						
		<p>4) Cover Panel is fixed to body by Hook in center area and side area.</p> <p>5) Separate the hook after pushing both end of Cover Panel as shown in the figure. (Watch out for the damage of the hook)</p> <p>6) Raise front part upward obliquely as shown in the figure and then remove the hooks.</p>	 <table border="1" data-bbox="938 577 1398 734"> <thead> <tr> <th colspan="2">HOOK</th> </tr> </thead> <tbody> <tr> <td>9/12K</td> <td></td> </tr> <tr> <td>18/24/30K</td> <td></td> </tr> </tbody> </table>   	HOOK		9/12K		18/24/30K	
HOOK									
9/12K									
18/24/30K									



No	Parts	Procedure	Remark
		<p>⚠ Caution: Assembly of Cover Panel after service end.</p> <ul style="list-style-type: none"> - Reassembly is in the reverse order of the removal. - Piping and drain hose must be careful not to damage and Progress must be done with both hands. 	  <p style="text-align: right;">Hook (Side)</p>  <p style="text-align: right;">Hook (Center)</p>  <p style="text-align: right;">Screw</p>  <p style="text-align: right;">Cap Screw</p>

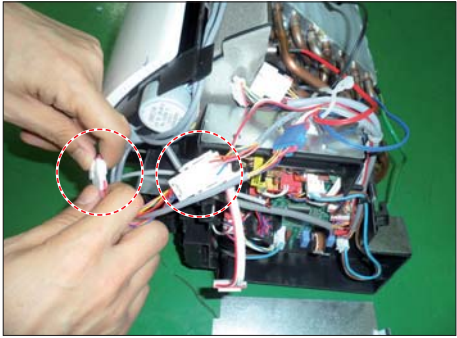
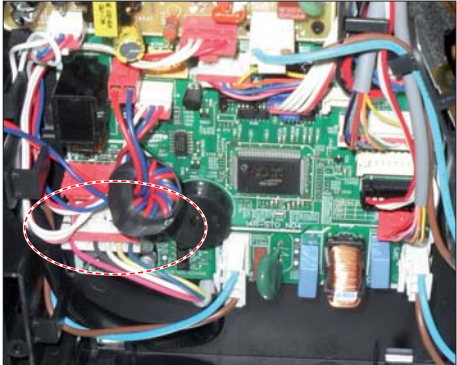
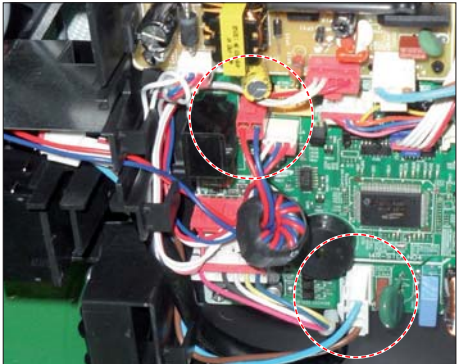
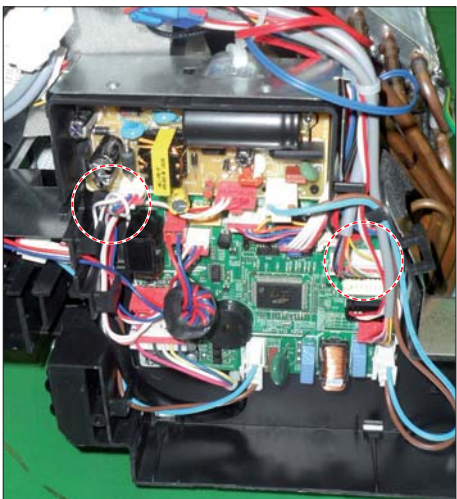

No	Parts	Procedure	Remark
		<p>7) To detach the PANEL-FRONT from the main frame, unfasten 2 screws at the bottom. (use + Screw Driver)</p> <p>8) To detach the COVER-PANEL from the main frame, loosen 4 HOOK Structures. When separate the hook : Use the (-) screw Driver. (-)Screw Driver Insert the hook and then pull the hook as shown on the right side. (Watch out for the damage of the hook)</p>	   

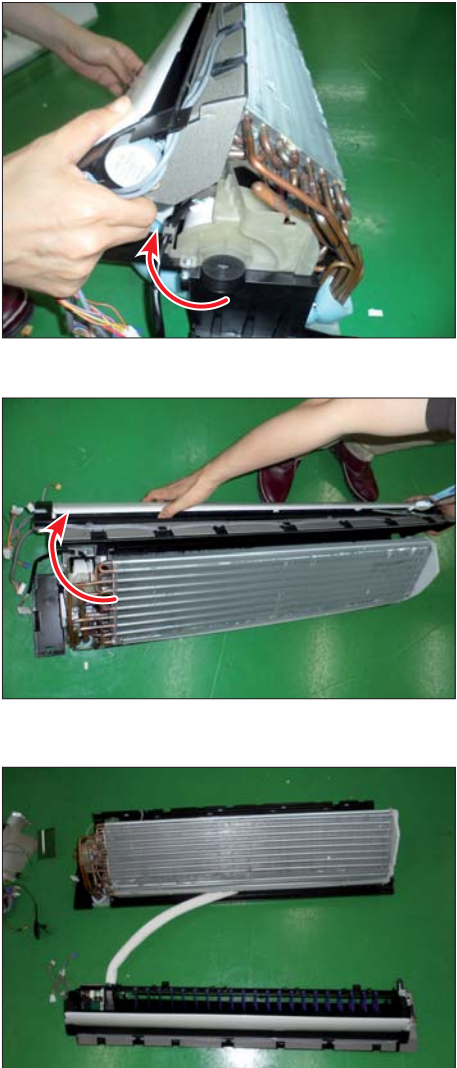
No	Parts	Procedure	Remark
		<p>9) Remove the Panel Frame from the Main Frame as shown on the right side.</p>	 
		<p>10) Remove the WIFI KIT connector. WIFI KIT connector is located of Panel Front. (For model with WIFI KIT)</p>	  

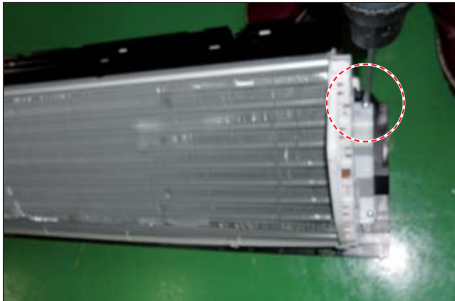
No	Parts	Procedure	Remark
2	CONTORLIN	<p>5) Loosen Stepping MOTOR Wire / BLADE Wire.</p> <p>6) Loosen MOTOR Wire. ⚠ Caution: When you separate the connector, pull pressing the locking button.</p> <p>7) Loosen the terminal block wires. ⚠ Caution: When you separate the connector, pull pressing the locking button.</p> <p>8) Loosen the Thermistor wire connector, Display wire connector. ⚠ Caution: When you separate the connector, pull pressing the locking button.</p>	   

No	Parts	Procedure	Remark
5	EVAPORATOR	<p>9) Take off the CASE-CONTROL from the main frame after loosen the remaining connector.</p> <p>⚠ Caution: When you separate the connector, pull pressing the locking button.</p>	
3	TRAY DRAIN	<p>1) To detach TRAY-DRAIN from the main frame, pull the bottom of the TRAY-DRAIN towards you.</p>	

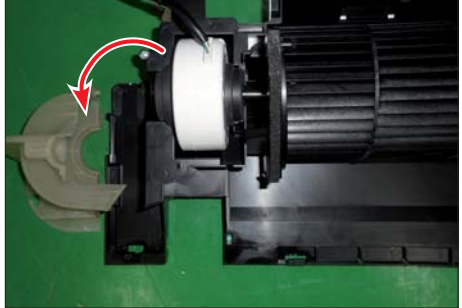

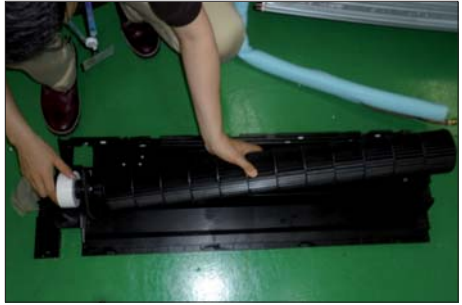



No	Parts	Procedure	Remark
4	Evaporator	<p>1) Detach the HOLDER PIPE.</p> <p>2) Unfasten the screw at the left side. (use + Screw Driver)</p> <p>3) Unfasten the screw at the right side. (use + Screw Driver)</p> <p>4) To detach Evaporator from the main frame, pull the bottom of the Evaporator towards you.</p>	   

No	Parts	Procedure	Remark
5	FAN MOTOR & CROSS FAN	<p>1) Unfasten the screw. (use + Screw Driver)</p> <p>2) Detach the FAN Motor case.</p> <p>3) Unfasten the screw a little. (use + Screw Driver)</p> <p>4) Pull the CROSS-FAN to the left side.</p>	   

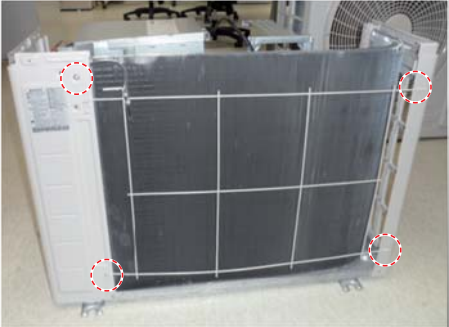
No	Parts	Procedure	Remark
6	Assy SPI Lamp	<p>1) Remove the Assy SPI Lamp from the Back Body as shown on the right side.</p> <p>⚠ Caution.</p> <ul style="list-style-type: none"> - Confirm Seal of backside necessarily after replace of Assy SPI Lamp. - Seal should be close adhesion to SPI Lamp. - Measure as shown on the right side since replace. <p>(If the seal is not close adhesion perfectly : Defectiveness can happen)</p>	

4-2. Outdoor Unit (12K)

No	Parts	Procedure	Remark
1	Common Work	<p>1) Loosen each screws and detach the Cabi Top Cover.</p> <p>2) Loosen screws of the Cabi Front and detach it.</p>	 <p>The 'Remark' column contains four photographs illustrating the disassembly process:</p> <ul style="list-style-type: none"> The top photo shows the outdoor unit with a red circle highlighting a screw on the top cover. The middle-left photo shows the top cover being lifted away from the unit, with a red circle highlighting a screw on the top edge. The middle-right photo shows a close-up of the front cover being detached from the side of the unit, with a red circle highlighting a screw. The bottom photo shows two views of the unit with the front cover removed, indicated by red rectangular boxes.

No	Parts	Procedure	Remark
		<p>3) Remove the 4 Cond Bar from the holder of outdoor unit cabinet.</p> <p>4) Loosen fixing screws from the Cabi Front Lh and detach it.</p> <p>5) Loosen fixing screws from the Cabi Side Rh and detach it.</p>	     



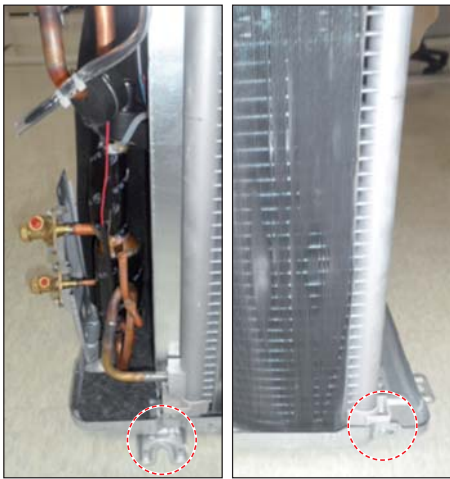

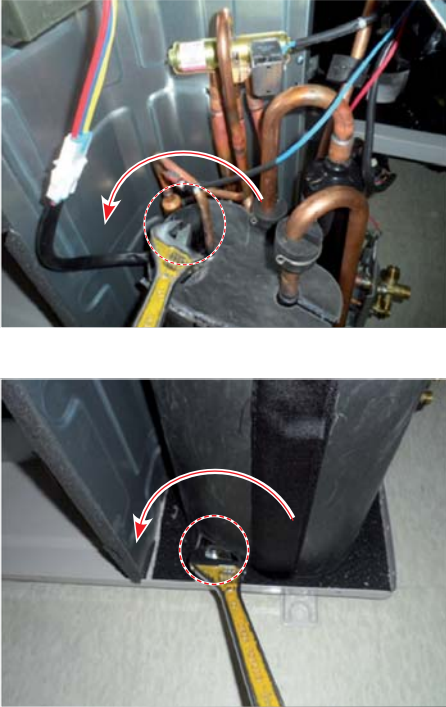
No	Parts	Procedure	Remark
2	Fan & Motor	<p>1) Detach the Nut Flange like the picture on the right side.(Turn clockwise because the screw is left-handed.) (Use Monkey Spanner.)</p> <p>2) Detach the Fan Propeller.</p> <p>3) Loosen 4 fixing screws to detach the Motor. (Use Monkey Spanner.)</p> <p>4) Disconnect the wire between Ass'y Control Out and Motor.</p> <p>8) Loosen 2 fixing bolts and detach the Bracket Motor</p>	   

No	Parts	Procedure	Remark
3	Ass'y Control Out	<p>1) To remove the Cover control box : Pull the motor wire is allow sufficient space as shown on the right side and then remove the screw.</p> <p>2) Detach several connectors from the Ass'y Control Out.</p> <p>3) Detach several connectors from the PCB of Ass'y Control Out.</p>	
4	Heat Exchanger	<p>1) Release the refrigerant at first.</p> <p>2) Loosen fixing screw on both sides.</p> <p>3) Disassemble the pipes in both inlet and outlet with welding torch.</p> <p>4) Detach the Heat Exchanger.</p>	

No	Parts	Procedure	Remark
5	Compressor	<p>1) Loosen the fixing nut and detach the Compressor Lead Wire. (Use Monkey Spanner.)</p> <p>2) Loosen the bolts at the bottom of Compressor like the picture on the right side. (Use Monkey Spanner.)</p>	

5. Disassembly WIFI

5-1 WIFI Case(ET/ZE)

No	Parts	Procedure	Remark
1	CASE	Separate Case-WIFI Top from Case-WIFI Button	
2	BUTTON	Separate Case-WIFI Top from Case-WIFI Button	
3	WIRE	Detach Assy Connector Wire from Case-WIFI Button *Caution When you separate the connector, pull pressing the locking button	
4	PBA	Separate PBA WIFI from Case-WIFI Button	

5-2 ASSY CONTROL IN

AR09 (12) HSFNBWKNET/ZE
 AR09HSFSBWKNZE
 AR12HSFSAWKNZE

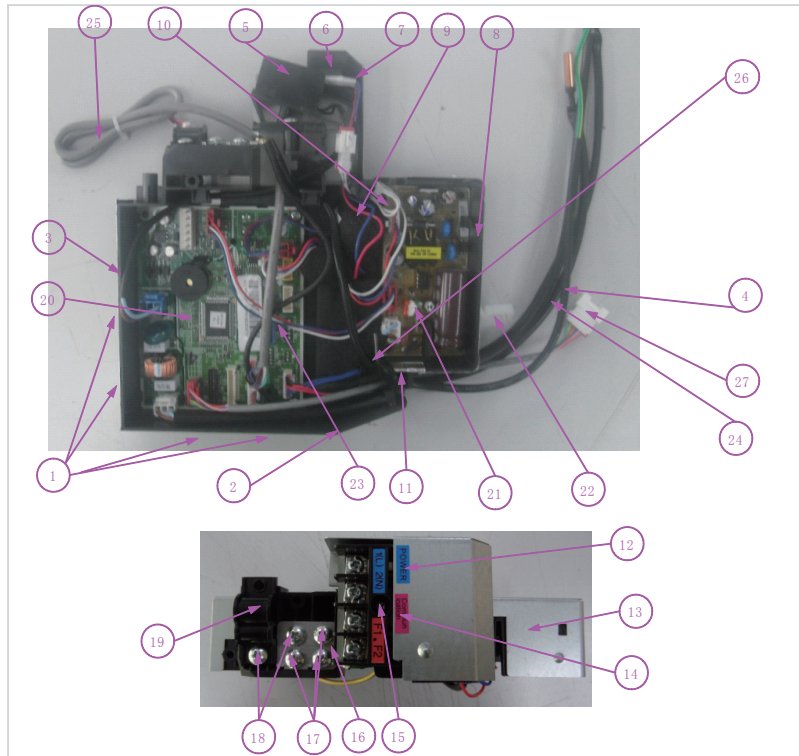

No	CODE	Description	Spec	Q' TY
	DB93-14235G	ASSY CONTROL IN		
1	DB63-03553C	Aluminum SHEET	10x10xT0.07, AL SHEET	4
2	DB61-05826A	CASE-CONTROL IN	CASE-CONTROL IN	1
3	DB93-14203A	POWER WIRE	T/B-main(power)	1
4	DB93-14245A	EARTH WIRE	EARTH WIRE	1
5	DB65-00326A	TERMINAL BLOCK	TERMINAL BLOCK	1
6	DB62-11656F	SEAL CUTT	PVC, BLACK, T1, W54	1
7	DB62-11680A	SEAL CONTROL	FLOCKED, BLACK, T1, W50, 54	1
8	DB68-02809A	ASSY-LABEL	ASSY-LABEL	1
9	DB93-14447A	COMMUNICATION WIRE	T/B-main(485)	1
10	DB93-14207A	FUSE WIRE	power-main(12V 5V)	1
11	DB63-03553D	Aluminum SHEET	22x22xT0.07, AL SHEET	1
12	DB68-33293A	ASSY-LABEL	ASSY-LABEL	1
13	DB61-05807A	PLATE-CONTROL IN	F01	1
14	DB68-33292A	ASSY-LABEL	ASSY-LABEL	1
15	DB91-00309A	SCREW	M3, L25, ZPC(WHT), SWRCH18A	1
16	DB61-05812A	PLATE	PLATE	1
17	6009-001001	SCREW	TH, M4, L10, ZPC(WHT), SWRCH18A	3
18	6002-000231	SCREW	M4, L12, ZPC(WHT), SWRCH18A	2
19	DB61-05871A	HOLDER-WIRE CLAMP	HOLDER-WIRE CLAMP	1
20	DB92-02873A	MAIN PBA	STD4	1
21	DB92-02861A	POWER PBA	STD11W	1
22	DB71-50021A	WIRE-SADDLE	WIRE-SADDLE	1
23	DB93-14208A	ASSY CONNECTOR WIRE-DC	power-main(310V 19V)	1
24	DB95-05163A	ASSY THERMISTOR IN	sensor lroom, 2evap	1
25	DB93-14221A	ASSY CONNECTOR WIRE-DC	FJM	1
26	DB93-14202A	ASSY CONNECTOR WIRE-DC	main-power(SMPS IN)	1
27	DB93-14211A	ASSY CONNECTOR WIRE-DC	main-Wifi	1

5-2 ASSY CONTROL IN

AR12HSFSRWKNER, AR12HSFNRWKNER

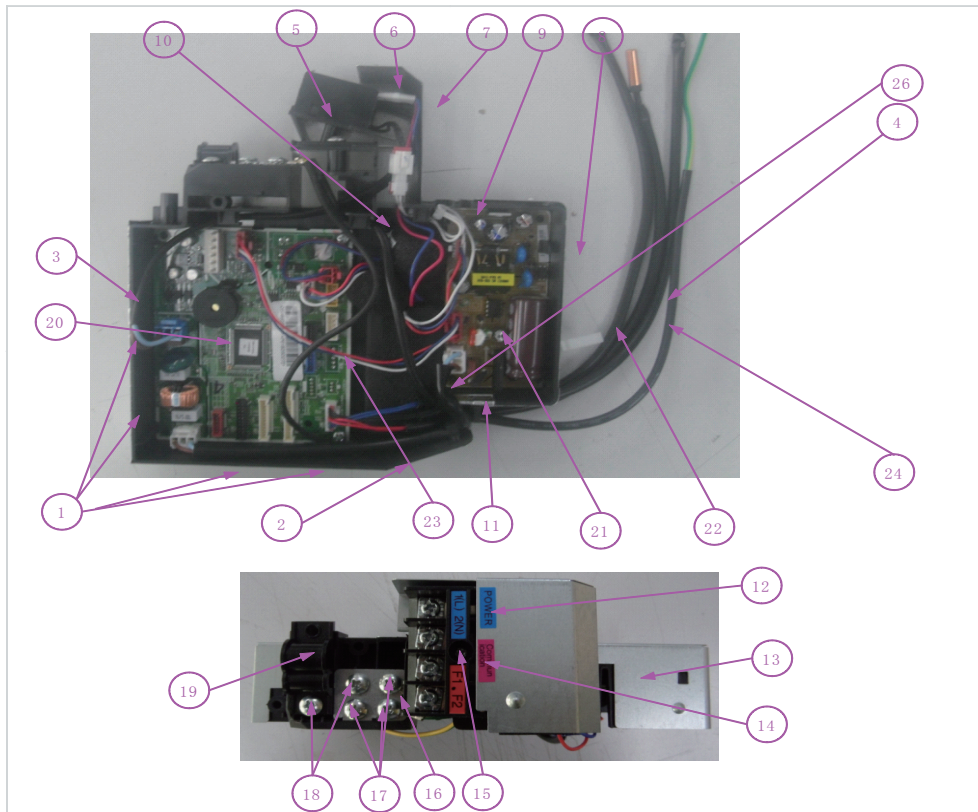

No	CODE	Description	Spec	Q' TY
	DB93-14235J	ASSY CONTROL IN		
1	DB63-03553C	ALUMINUM SHEET	10x10xT0.07, AL SHEET	4
2	DB61-05826A	CASE-CONTROL IN	CASE-CONTROL IN	1
3	DB93-14203A	POWER WIRE	T/B-main(power)	1
4	DB93-14245A	EARTH WIRE	EARTH WIRE	1
5	DB65-00326A	TERMINAL BLOCK	TERMINAL BLOCK	1
6	DB62-11656F	SEAL CUTT	PVC, BLACK, T1, W54	1
7	DB62-11680A	SEAL CONTROL	FLOCKED, BLACK, T1, W50, 54	1
8	DB68-02809A	ASSY-LABEL	ASSY-LABEL	1
9	DB93-14447A	COMMUNICATION WIRE	T/B-main(485)	1
10	DB93-14207A	FUSE WIRE	power-main(12V 5V)	1
11	DB63-03553D	ALUMINUM SHEET	22x22xT0.07, AL SHEET	1
12	DB68-33293A	ASSY-LABEL	ASSY-LABEL	1
13	DB61-05807A	PLATE-CONTROL IN	F01	1
14	DB68-33292A	ASSY-LABEL	ASSY-LABEL	1
15	DB91-00309A	SCREW	M3, L25, ZPC(WHT), SWRCH18A	1
16	DB61-05812A	PLATE	PLATE	1
17	6009-001001	SCREW	TH, M4, L10, ZPC(WHT), SWRCH18A	3
18	6002-000231	SCREW	M4, L12, ZPC(WHT), SWRCH18A	2
19	DB61-05871A	HOLDER-WIRE CLAMP	HOLDER-WIRE CLAMP	1
20	DB92-02873A	MAIN PBA	STD4	1
21	DB92-02861A	POWER PBA	STD11W	1
22	DB71-50021A	WIRE-SADDLE	WIRE-SADDLE	1
23	DB93-14208A	ASSY CONNECTOR WIRE-DC	power-main(310V 19V)	1
24	DB95-05163A	ASSY THERMISTOR IN	sensor 1room, 2evap	1
26	DB93-14202A	ASSY CONNECTOR WIRE-DC	main-power(SMPS IN)	1

5-2 ASSY CONTROL IN

AR09HSSDRWKNER

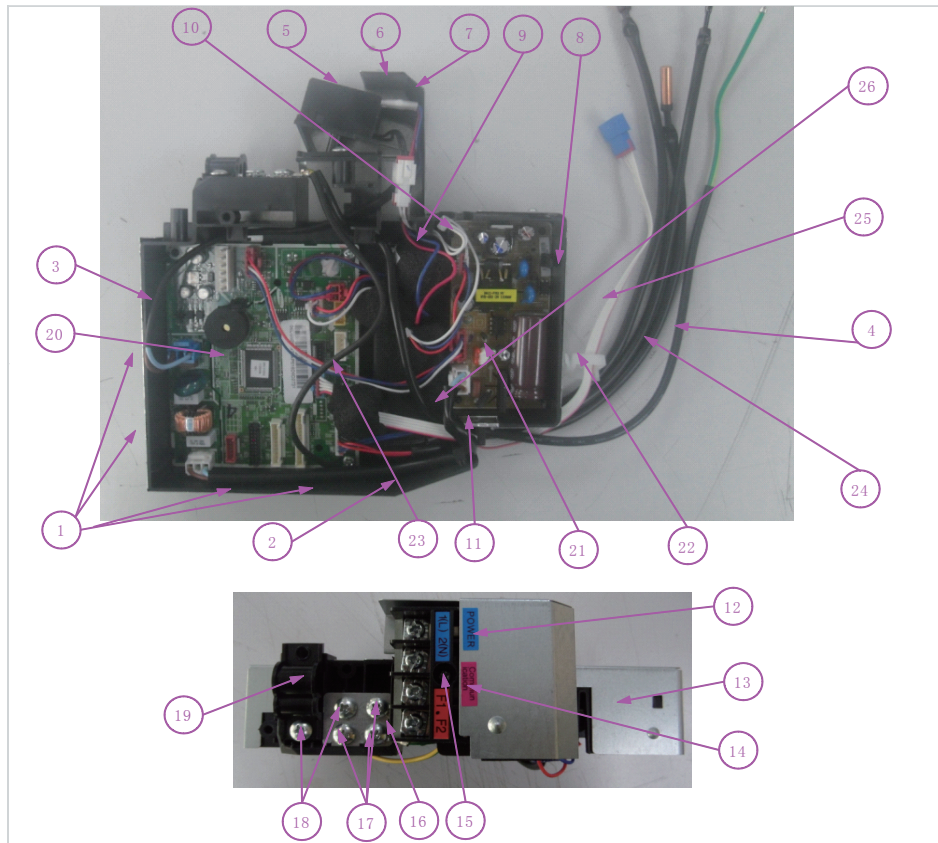

No	CODE	Description	Spec	Q' TY
	DB93-14235K	ASSY CONTROL IN		
1	DB63-03553C	Aluminum SHEET	10x10xT0.07, AL SHEET	4
2	DB61-05826A	CASE-CONTROL IN	CASE-CONTROL IN	1
3	DB93-14203A	POWER WIRE	T/B-main (power)	1
4	DB93-14245A	EARTH WIRE	EARTH WIRE	1
5	DB65-00326A	TERMINAL BLOCK	TERMINAL BLOCK	1
6	DB62-11656F	SEAL CUTT	PVC, BLACK, T1, W54	1
7	DB62-11680A	SEAL CONTROL	FLOCKED, BLACK, T1, W50, 54	1
8	DB68-02809A	ASSY-LABEL	ASSY-LABEL	1
9	DB93-14447A	COMMUNICATION WIRE	T/B-main (485)	1
10	DB93-14207A	FUSE WIRE	power-main (12V 5V)	1
11	DB63-03553D	Aluminum SHEET	22x22xT0.07, AL SHEET	1
12	DB68-33293A	ASSY-LABEL	ASSY-LABEL	1
13	DB61-05807A	PLATE-CONTROL IN	F01	1
14	DB68-33292A	ASSY-LABEL	ASSY-LABEL	1
15	DB91-00309A	SCREW	M3, L25, ZPC (WHT), SWRCH18A	1
16	DB61-05812A	PLATE	PLATE	1
17	6009-001001	SCREW	TH, M4, L10, ZPC (WHT), SWRCH18A	3
18	6002-000231	SCREW	M4, L12, ZPC (WHT), SWRCH18A	2
19	DB61-05871A	HOLDER-WIRE CLAMP	HOLDER-WIRE CLAMP	1
20	DB92-02873A	MAIN PBA	STD4	1
21	DB92-02861A	POWER PBA	STD11W	1
22	DB71-50021A	WIRE-SADDLE	WIRE-SADDLE	1
23	DB93-14208A	ASSY CONNECTOR WIRE-DC	power-main (310V 19V)	1
24	DB95-05163A	ASSY THERMISTOR IN	sensor Iroom, 2evap	1
25	DB93-14205A	ASSY CONNECTOR WIRE-DC	Step-main (Left)	1
26	DB93-14202A	ASSY CONNECTOR WIRE-DC	main-power (SMPS IN)	1

5-3 Assy Control Out

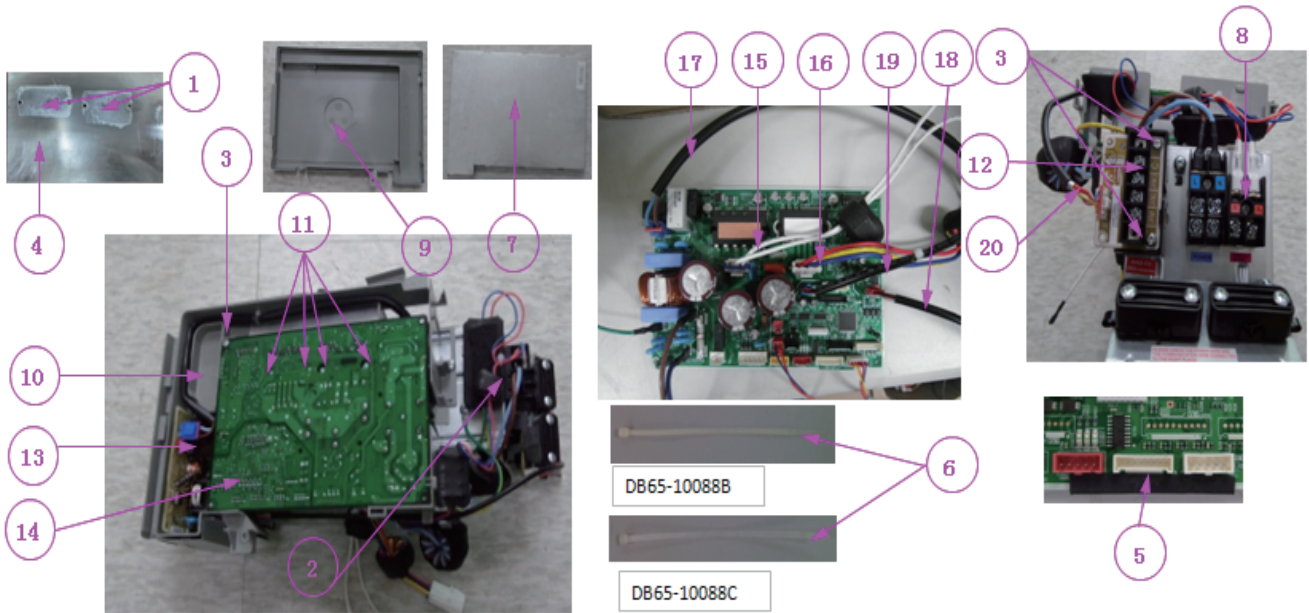

No	NAME	CODE	Q' ty	unit	REMARK
	ASSYCONTROLOUT	DB93-14201C			
1	GREASE-SILICON	0205-000178	0.002	KG	
2	SCREW-TAPPING	6002-000527	1	PC	
3	SCREW-TAPPING	6002-000536	1	PC	
4	HEATSINK	DB62-11646A	1	PC	
5	SEALCUTT	DB62-11656B	0	M	
6	CABLETIE	DB65-10088B	2	PC	W3.6*L150
7	LABELBARCODE	DB68-02809A	1	PC	
8	ASSYCASECONTROLOUT	DB90-06308P	1	PC	
9	ASSYCOVERCONTROL-UP	DB90-07729A	1	PC	组件
10	ASSYCASECONTROL	DB90-07833A	1	PC	
11	ASSY-SCREWMACHINE	DB91-00933A	4	PC	
12	ASSYPCBSUB	DB92-02836A	0	PC	
13	ASSYMODULE	DB92-02862A	1	PC	
14	ASSYPCBMAIN	DB92-02866A	1	PC	
15	ASSYCONNECTORWIRE	DB93-09493C	1	PC	
16	ASSYCONNECTORWIRE	DB93-09497E	1	PC	
17	ASSYCONNECTORWIRE-POWER	DB93-14275A	1	PC	AC
18	ASSYCONNECTORWIRE-DCSIGN	DB93-14276A	1	PC	
19	ASSYCONNECTORWIRE-DCSIGN	DB93-14277A	1	PC	
20	ASSYCONNECTORWIRE-DCSIGN	DB93-14278A	0	PC	

6. Electrical Parts List

6-1 INDOOR MAIN PCB (DB92-02873A)

Parts Code	Design Loc	Parts Description	Quantity
0202-001338	SOLDER-BAR	SOLDER-BAR	0.17
0202-001463	SOLDER-WIRE	SOLDER-WIRE	1.51
0204-004665	FLUX	FLUX	0.14
0204-005794	SOLVENT	SOLVENT	1
0502-000245	Q701	TR-POWER	1
1405-001239	VA71	VARISTOR	1
2301-002032	XC71	C-FILM,LEAD-PPF	1
2301-002032	XC72	C-FILM,LEAD-PPF	1
3002-001139	BZ61	BUZZER-PIEZO	1
3711-000177	CN21	HEADER-BOARD TO CABLE	1
3711-000203	CN75	HEADER-BOARD TO CABLE	1
3711-000296	CN72	HEADER-BOARD TO CABLE	1
3711-002001	CN31	HEADER-BOARD TO CABLE	1
3711-003404	CN71	HEADER-BOARD TO CABLE	1
3711-003845	CN91	HEADER-BOARD TO CABLE	1
3711-004122	CN32	HEADER-BOARD TO CABLE	1
3711-004236	CN43	HEADER-BOARD TO CABLE	1
3711-005096	CN63	HEADER-BOARD TO CABLE	1
3711-005097	CN62	HEADER-BOARD TO CABLE	1
3711-005504	CN51	HEADER-BOARD TO CABLE	1
DB27-00096A	FT71	COIL CHOKE	1
DB67-00942A	VA71-1	CAP	1
DB94-04097A		ASSY PCB AUTO	1
0501-000362	Q801	TR-SMALL SIGNAL	1
1404-001194	PTC2	THERMISTOR-PTC	1
3601-001765	F701	FUSE-ETC	1
3711-000024	CN76	HEADER-BOARD TO CABLE	1
3711-000941	CN81	HEADER-BOARD TO CABLE	1
3711-000998	CN77	CONNECTOR-HEADER	1
3711-000999	CN61	HEADER-BOARD TO CABLE	1
DB94-04098A		ASSY PCB SMD	1
0202-001459	SOLDER-CREAM	SOLDER-CREAM	0.32
0402-001741	D701	DIODE-RECTIFIER	1
0406-001204	CD81	DIODE-TVS	1
0406-001204	CD82	DIODE-TVS	1
0406-001204	CD83	DIODE-TVS	1
0501-000465	Q702	TR-SMALL SIGNAL	1
0504-001080	Q601	TR-DIGITAL	1
0504-001080	Q802	TR-DIGITAL	1
0506-000175	IC05	TR-ARRAY	1
0506-000175	IC06	TR-ARRAY	1
0604-001002	PC03	PHOTO-COUPLER	1
0604-001002	PC04	PHOTO-COUPLER	1
0604-001002	PC05	PHOTO-COUPLER	1
0801-000393	IC08	IC-CMOS LOGIC	1
1006-001325	IC07	IC-BUS TRANSCEIVER	1
1202-000104	IC11	IC-VOLTAGE COMP.	1
1203-006245	IC03	IC-VOL. DETECTOR	1
1203-007526	IC02	IC-POSI.FIXED REG.	1
2007-000029	R850	R-CHIP	1
2007-000029	R851	R-CHIP	1
2007-000067	R713	R-CHIP	1
2007-000072	R717	R-CHIP	1
2007-000076	R601	R-CHIP	1
2007-000076	R602	R-CHIP	1
2007-000076	R716	R-CHIP	1
2007-000078	R703	R-CHIP	1
2007-000078	R706	R-CHIP	1

INDOOR MAIN PCB (DB92-02873A) cont.

Parts Code	Design Loc	Parts Description	Quantity
2007-000078	R805	R-CHIP	1
2007-000078	R815	R-CHIP	1
2007-000084	R707	R-CHIP	1
2007-000087	R708	R-CHIP	1
2007-000090	R701	R-CHIP	1
2007-000090	R704	R-CHIP	1
2007-000090	R705	R-CHIP	1
2007-000090	R723	R-CHIP	1
2007-000090	R801	R-CHIP	1
2007-000090	R802	R-CHIP	1
2007-000090	R803	R-CHIP	1
2007-000090	R804	R-CHIP	1
2007-000090	R816	R-CHIP	1
2007-000116	R825	R-CHIP	1
2007-000130	R715	R-CHIP	1
2007-000138	R508	R-CHIP	1
2007-000138	R515	R-CHIP	1
2007-000138	R516	R-CHIP	1
2007-000138	R517	R-CHIP	1
2007-000138	R518	R-CHIP	1
2007-000138	R519	R-CHIP	1
2007-000138	R520	R-CHIP	1
2007-000138	R539	R-CHIP	1
2007-000138	R542	R-CHIP	1
2007-000138	R809	R-CHIP	1
2007-000140	R538	R-CHIP	1
2007-000140	R545	R-CHIP	1
2007-000140	R806	R-CHIP	1
2007-000140	R901	R-CHIP	1
2007-000143	R511	R-CHIP	1
2007-000143	R512	R-CHIP	1
2007-000143	R513	R-CHIP	1
2007-000148	R502	R-CHIP	1
2007-000148	R503	R-CHIP	1
2007-000148	R504	R-CHIP	1
2007-000148	R505	R-CHIP	1
2007-000148	R506	R-CHIP	1
2007-000148	R507	R-CHIP	1
2007-000148	R510	R-CHIP	1
2007-000148	R521	R-CHIP	1
2007-000148	R522	R-CHIP	1
2007-000148	R523	R-CHIP	1
2007-000148	R524	R-CHIP	1
2007-000148	R525	R-CHIP	1
2007-000148	R526	R-CHIP	1
2007-000148	R527	R-CHIP	1
2007-000148	R528	R-CHIP	1
2007-000148	R529	R-CHIP	1
2007-000148	R530	R-CHIP	1
2007-000148	R531	R-CHIP	1
2007-000148	R532	R-CHIP	1
2007-000148	R533	R-CHIP	1
2007-000148	R534	R-CHIP	1
2007-000148	R543	R-CHIP	1
2007-000148	R544	R-CHIP	1
2007-000148	R807	R-CHIP	1
2007-000148	R808	R-CHIP	1
2007-000148	R810	R-CHIP	1
2007-000148	R824	R-CHIP	1
2007-000148	R903	R-CHIP	1

INDOOR MAIN PCB (DB92-02873A) cont.

Parts Code	Design Loc	Parts Description	Quantity
2007-000148	R904	R-CHIP	1
2007-000157	R902	R-CHIP	1
2007-000162	R820	R-CHIP	1
2007-000162	R821	R-CHIP	1
2007-000171	R831	R-CHIP	1
2007-000171	R833	R-CHIP	1
2007-000171	R835	R-CHIP	1
2007-000171	R837	R-CHIP	1
2007-000171	R839	R-CHIP	1
2007-000171	R843	R-CHIP	1
2007-000303	R702	R-CHIP	1
2007-000385	R115	R-CHIP	1
2007-000455	R712	R-CHIP	1
2007-000475	R709	R-CHIP	1
2007-000924	R112	R-CHIP	1
2007-000924	R113	R-CHIP	1
2007-000924	R114	R-CHIP	1
2007-000939	R711	R-CHIP	1
2007-001096	R714	R-CHIP	1
2007-001313	R404	R-CHIP	1
2007-001313	R405	R-CHIP	1
2007-001313	R406	R-CHIP	1
2007-001313	R410	R-CHIP	1
2007-001313	R811	R-CHIP	1
2007-001433	R618	R-CHIP	1
2007-007313	R401	R-CHIP	1
2007-007313	R402	R-CHIP	1
2007-007313	R403	R-CHIP	1
2007-009922	R301	R-CHIP	1
2007-009922	R302	R-CHIP	1
2007-009922	R303	R-CHIP	1
2203-000257	C705	C-CER,CHIP	1
2203-000257	C801	C-CER,CHIP	1
2203-000438	C508	C-CER,CHIP	1
2203-000438	C516	C-CER,CHIP	1
2203-000438	C520	C-CER,CHIP	1
2203-000438	C901	C-CER,CHIP	1
2203-000440	C711	C-CER,CHIP	1
2203-000440	C715	C-CER,CHIP	1
2203-001071	C519	C-CER,CHIP	1
2203-005249	C401	C-CER,CHIP	1
2203-005249	C402	C-CER,CHIP	1
2203-005249	C403	C-CER,CHIP	1
2203-005249	C511	C-CER,CHIP	1
2203-005249	C513	C-CER,CHIP	1
2203-005249	C514	C-CER,CHIP	1
2203-005249	C517	C-CER,CHIP	1
2203-005249	C522	C-CER,CHIP	1
2203-005249	C529	C-CER,CHIP	1
2203-005249	C530	C-CER,CHIP	1
2203-005249	C531	C-CER,CHIP	1
2203-005249	C533	C-CER,CHIP	1
2203-005249	C702	C-CER,CHIP	1
2203-005249	C704	C-CER,CHIP	1
2203-005249	C710	C-CER,CHIP	1
2203-005249	C712	C-CER,CHIP	1
2203-005249	C713	C-CER,CHIP	1
2203-005249	C802	C-CER,CHIP	1
2203-005249	C803	C-CER,CHIP	1
2203-005249	C805	C-CER,CHIP	1

INDOOR MAIN PCB (DB92-02873A) cont.

Parts Code	Design Loc	Parts Description	Quantity
2203-005249	C806	C-CER,CHIP	1
2203-005249	C807	C-CER,CHIP	1
2203-005249	C809	C-CER,CHIP	1
2203-006496	C707	C-CER,CHIP	1
2203-006960	C708	C-CER,CHIP	1
2203-007486	C509	C-CER,CHIP	1
2203-007486	C512	C-CER,CHIP	1
2203-007486	C515	C-CER,CHIP	1
2203-007486	C518	C-CER,CHIP	1
2203-007486	C521	C-CER,CHIP	1
2203-007486	C523	C-CER,CHIP	1
2203-007486	C526	C-CER,CHIP	1
2203-007486	C528	C-CER,CHIP	1
2203-007486	C551	C-CER,CHIP	1
2203-007486	C552	C-CER,CHIP	1
2203-007486	C804	C-CER,CHIP	1
2203-007486	C808	C-CER,CHIP	1
2402-000120	C706	C-AL,SMD	1
2402-001145	C701	C-AL,SMD	1
2402-001145	C703	C-AL,SMD	1
2802-001211	X501	RESONATOR-CERAMIC	1
DB41-01221A	PCB MAIN	PCB MAIN	1
DB91-01550A	IC04	ASSY MICOM	1
0903-001864	-	IC-MICROCONTROLLER	1
DB98-31449A	ASSY-LABEL MICOM	ASSY-LABEL MICOM	1
DC68-02310A	LABEL-BAR CODE	LABEL-BAR CODE	1

6-2 OUTDOOR MAIN PBA(DB92-02866A)

Parts Code	Design Loc	Description	Spec.	Q'TY
0401-001099	D020	DIODE-SWITCHING	1N4148WS, 75V, 150mA, SOD-323, TP	1
0401-001099	D021	DIODE-SWITCHING	1N4148WS, 75V, 150mA, SOD-323, TP	1
0401-001099	D030	DIODE-SWITCHING	1N4148WS, 75V, 150mA, SOD-323, TP	1
0401-001099	D152	DIODE-SWITCHING	1N4148WS, 75V, 150mA, SOD-323, TP	1
0401-001099	D153	DIODE-SWITCHING	1N4148WS, 75V, 150mA, SOD-323, TP	1
0401-001099	D454	DIODE-SWITCHING	1N4148WS, 75V, 150mA, SOD-323, TP	1
0401-001099	D500	DIODE-SWITCHING	1N4148WS, 75V, 150mA, SOD-323, TP	1
0401-001099	D501	DIODE-SWITCHING	1N4148WS, 75V, 150mA, SOD-323, TP	1
0401-001099	D502	DIODE-SWITCHING	1N4148WS, 75V, 150mA, SOD-323, TP	1
0401-001099	D503	DIODE-SWITCHING	1N4148WS, 75V, 150mA, SOD-323, TP	1
0401-001099	D504	DIODE-SWITCHING	1N4148WS, 75V, 150mA, SOD-323, TP	1
0401-001099	D505	DIODE-SWITCHING	1N4148WS, 75V, 150mA, SOD-323, TP	1
0401-001099	D507	DIODE-SWITCHING	1N4148WS, 75V, 150mA, SOD-323, TP	1
0401-001099	D508	DIODE-SWITCHING	1N4148WS, 75V, 150mA, SOD-323, TP	1
0401-001099	D904	DIODE-SWITCHING	1N4148WS, 75V, 150mA, SOD-323, TP	1
0401-001099	D905	DIODE-SWITCHING	1N4148WS, 75V, 150mA, SOD-323, TP	1
0402-001795	D903	DIODE-RECTIFIER	US1M, 1000V, 1A, SMA, TP	1
0403-001499	ZD401	DIODE-ZENER	MMSZ5252B, 22.8/25.2V, 500mW, SOD-123, TP	1
0403-001499	ZD420	DIODE-ZENER	MMSZ5252B, 22.8/25.2V, 500mW, SOD-123, TP	1
0404-001020	D491	DIODE-SCHOTTKY	BAT54C, 30V, 200mA, SOT-23, TP	1
0404-001020	D492	DIODE-SCHOTTKY	BAT54C, 30V, 200mA, SOT-23, TP	1
0406-001204	TD301	DIODE-TVS	SMBJ5.0CA, 6.4/-7.25V, 600W, SMB	1
0406-001204	TD302	DIODE-TVS	SMBJ5.0CA, 6.4/-7.25V, 600W, SMB	1
0406-001204	TD303	DIODE-TVS	SMBJ5.0CA, 6.4/-7.25V, 600W, SMB	1
0501-000465	Q551	TR-SMALL SIGNAL	MMBT3904, NPN, 350mW, SOT-23, TP, 30-300	1
0504-001008	Q351	TR-DIGITAL	RN2427, PNP, 200mW, 2.2K/10Kohm, SOT-23, TP	1
0504-001008	Q352	TR-DIGITAL	RN2427, PNP, 200mW, 2.2K/10Kohm, SOT-23, TP	1
0504-001008	Q901	TR-DIGITAL	RN2427, PNP, 200mW, 2.2K/10Kohm, SOT-23, TP	1
0504-001008	Q903	TR-DIGITAL	RN2427, PNP, 200mW, 2.2K/10Kohm, SOT-23, TP	1
0504-001044	Q151	TR-DIGITAL	KRA226M, PNP, 400mW, 2.2K/10K, TO-92M, TP	1
0504-001080	Q902	TR-DIGITAL	KRC246S, NPN, 200mW, 2.2K/10Kohm, SOT-23, TP	1
0506-000175	C061	TR-ARRAY	2003, NPN, 7, 1W, SOP-16, ST, 1000	1
0506-000175	C701	TR-ARRAY	2003, NPN, 7, 1W, SOP-16, ST, 1000	1
0506-000175	C702	TR-ARRAY	2003, NPN, 7, 1W, SOP-16, ST, 1000	1
0601-002423	LED801	LED	SMD (REVERSE), RED, 3.2x1.6mm, 639nm, 3.2x1.6x1.1mm	1
0601-002955	LED803	LED	SMD (REVERSE), YEL, 1.6x1.5mm, 588nm, 3.2x1.6x1.1mm	1
0601-002956	LED551	LED	SMD (REVERSE), GRN, 1.6x1.5mm, 3.2x1.6x1.1mm	1
0601-002956	LED802	LED	SMD (REVERSE), GRN, 1.6x1.5mm, 3.2x1.6x1.1mm	1
0604-001172	PC151	PHOTO-COUPLER	TR, 150-300, 200mW, SOP, TP	1
0604-001172	PC351	PHOTO-COUPLER	TR, 150-300, 200mW, SOP, TP	1
0604-001172	PC352	PHOTO-COUPLER	TR, 150-300, 200mW, SOP, TP	1
0801-000393	IC302	IC-CMOS LOGIC	74HC86, OR GATE, SOP, 14P, 150MIL, QUAD, ST, -, 2.0/6.0V, 0.26V, -40to+85C, 180mW, 4.2V, 1uA,	1
1006-001325	IC301	IC-BUS TRANSCEIVER	ISL81487LIBZ, SO, 8P, 4.9x3.8mm, SINGLE, ST, PLASTIC, 5V, -40to+85C, 520mW, 1, 1, 1.5/5.0V	1
1201-002946	IC451	IC-OP AMP	TSSOP, TR, 14P, 5x4.4x1.2mm, 100, 5.5V, -40to+85C, 63dB, 1, 1nA, 1nA, 1.7mV	1
1203-002835	IC154	IC-POSI. FIXED REG.	7805, 3P, 6.6x6.1mm, PLASTIC, 4.8V/5.2V, 1.3W, -40to+85, 1A, TP	1
1203-002986	IC155	IC-POSI. FIXED REG.	7812, 3P, 6.6x6.1mm, PLASTIC, 11.5/12.5V, 1.3, 150C, 1A, TP	1
1203-004967	IC502	IC-VOL. DETECTOR	KIA7042AT, TSM, 3P, 2.9x1.6mm, PLASTIC, 4.2V, 350mW, -30to+75C, 20mA, -, -	1
1404-001498	PTC020	THERMISTOR-PTC	40ohm, 25%, 290Vac, 7A, TR	1
1405-000154	VA002	VARIATOR	560V, 460Vdc, 4500A, 17.5x7.5mm, BK, 920V, 600pF	1
1405-000154	VA003	VARIATOR	560V, 460Vdc, 4500A, 17.5x7.5mm, BK, 920V, 600pF	1
1405-001239	VA001	VARIATOR	680V, 560Vdc, 6000A, 17x7.3mm, BK, 1120V, 350pF	1
1405-001239	VA401	VARIATOR	680V, 560Vdc, 6000A, 17x7.3mm, BK, 1120V, 350pF	1
2007-000043	R424	R-CHIP	1Kohm, 1%, 1/10W, TP, 1608	1
2007-000070	R309	R-CHIP	0ohm, 5%, 1/10W, TP, 1608	1
2007-000074	R152	R-CHIP	100ohm, 5%, 1/10W, TP, 1608	1
2007-000074	R210	R-CHIP	100ohm, 5%, 1/10W, TP, 1608	1
2007-000074	R213	R-CHIP	100ohm, 5%, 1/10W, TP, 1608	1
2007-000074	R233	R-CHIP	100ohm, 5%, 1/10W, TP, 1608	1
2007-000074	R234	R-CHIP	100ohm, 5%, 1/10W, TP, 1608	1
2007-000074	R401	R-CHIP	100ohm, 5%, 1/10W, TP, 1608	1

OUTDOOR MAIN PBA (DB92-02866A)

PartsCode	Design Loc	Description	Spec.	Q' TY
2007-000074	R402	R-CH P	100ohm ,5% ,1/10W ,TP,1608	1
2007-000074	R403	R-CH P	100ohm ,5% ,1/10W ,TP,1608	1
2007-000074	R404	R-CH P	100ohm ,5% ,1/10W ,TP,1608	1
2007-000074	R405	R-CH P	100ohm ,5% ,1/10W ,TP,1608	1
2007-000074	R406	R-CH P	100ohm ,5% ,1/10W ,TP,1608	1
2007-000074	R407	R-CH P	100ohm ,5% ,1/10W ,TP,1608	1
2007-000074	R420	R-CH P	100ohm ,5% ,1/10W ,TP,1608	1
2007-000074	R422	R-CH P	100ohm ,5% ,1/10W ,TP,1608	1
2007-000074	R516	R-CH P	100ohm ,5% ,1/10W ,TP,1608	1
2007-000074	R519	R-CH P	100ohm ,5% ,1/10W ,TP,1608	1
2007-000074	R562	R-CH P	100ohm ,5% ,1/10W ,TP,1608	1
2007-000076	R153	R-CH P	330ohm ,5% ,1/10W ,TP,1608	1
2007-000076	R255	R-CH P	330ohm ,5% ,1/10W ,TP,1608	1
2007-000076	R256	R-CH P	330ohm ,5% ,1/10W ,TP,1608	1
2007-000076	R257	R-CH P	330ohm ,5% ,1/10W ,TP,1608	1
2007-000076	R258	R-CH P	330ohm ,5% ,1/10W ,TP,1608	1
2007-000076	R352	R-CH P	330ohm ,5% ,1/10W ,TP,1608	1
2007-000076	R353	R-CH P	330ohm ,5% ,1/10W ,TP,1608	1
2007-000076	R512	R-CH P	330ohm ,5% ,1/10W ,TP,1608	1
2007-000076	R567	R-CH P	330ohm ,5% ,1/10W ,TP,1608	1
2007-000076	R904	R-CH P	330ohm ,5% ,1/10W ,TP,1608	1
2007-000078	R303	R-CH P	1Kohm ,5% ,1/10W ,TP,1608	1
2007-000078	R307	R-CH P	1Kohm ,5% ,1/10W ,TP,1608	1
2007-000078	R308	R-CH P	1Kohm ,5% ,1/10W ,TP,1608	1
2007-000078	R351	R-CH P	1Kohm ,5% ,1/10W ,TP,1608	1
2007-000078	R354	R-CH P	1Kohm ,5% ,1/10W ,TP,1608	1
2007-000078	R503	R-CH P	1Kohm ,5% ,1/10W ,TP,1608	1
2007-000078	R504	R-CH P	1Kohm ,5% ,1/10W ,TP,1608	1
2007-000078	R505	R-CH P	1Kohm ,5% ,1/10W ,TP,1608	1
2007-000078	R508	R-CH P	1Kohm ,5% ,1/10W ,TP,1608	1
2007-000078	R509	R-CH P	1Kohm ,5% ,1/10W ,TP,1608	1
2007-000078	R515	R-CH P	1Kohm ,5% ,1/10W ,TP,1608	1
2007-000078	R529	R-CH P	1Kohm ,5% ,1/10W ,TP,1608	1
2007-000078	R530	R-CH P	1Kohm ,5% ,1/10W ,TP,1608	1
2007-000078	R556	R-CH P	1Kohm ,5% ,1/10W ,TP,1608	1
2007-000078	R557	R-CH P	1Kohm ,5% ,1/10W ,TP,1608	1
2007-000078	R558	R-CH P	1Kohm ,5% ,1/10W ,TP,1608	1
2007-000078	R560	R-CH P	1Kohm ,5% ,1/10W ,TP,1608	1
2007-000078	R563	R-CH P	1Kohm ,5% ,1/10W ,TP,1608	1
2007-000080	R522	R-CH P	2Kohm ,5% ,1/10W ,TP,1608	1
2007-000082	R421	R-CH P	3.3Kohm ,5% ,1/10W ,TP,1608	1
2007-000084	R211	R-CH P	4.7Kohm ,5% ,1/10W ,TP,1608	1
2007-000084	R212	R-CH P	4.7Kohm ,5% ,1/10W ,TP,1608	1
2007-000084	R214	R-CH P	4.7Kohm ,5% ,1/10W ,TP,1608	1
2007-000084	R215	R-CH P	4.7Kohm ,5% ,1/10W ,TP,1608	1
2007-000084	R216	R-CH P	4.7Kohm ,5% ,1/10W ,TP,1608	1
2007-000084	R217	R-CH P	4.7Kohm ,5% ,1/10W ,TP,1608	1
2007-000084	R218	R-CH P	4.7Kohm ,5% ,1/10W ,TP,1608	1
2007-000084	R219	R-CH P	4.7Kohm ,5% ,1/10W ,TP,1608	1
2007-000084	R220	R-CH P	4.7Kohm ,5% ,1/10W ,TP,1608	1
2007-000084	R408	R-CH P	4.7Kohm ,5% ,1/10W ,TP,1608	1
2007-000084	R501	R-CH P	4.7Kohm ,5% ,1/10W ,TP,1608	1
2007-000084	R506	R-CH P	4.7Kohm ,5% ,1/10W ,TP,1608	1
2007-000084	R507	R-CH P	4.7Kohm ,5% ,1/10W ,TP,1608	1
2007-000084	R510	R-CH P	4.7Kohm ,5% ,1/10W ,TP,1608	1
2007-000084	R511	R-CH P	4.7Kohm ,5% ,1/10W ,TP,1608	1
2007-000084	R517	R-CH P	4.7Kohm ,5% ,1/10W ,TP,1608	1
2007-000084	R518	R-CH P	4.7Kohm ,5% ,1/10W ,TP,1608	1
2007-000084	R520	R-CH P	4.7Kohm ,5% ,1/10W ,TP,1608	1
2007-000084	R521	R-CH P	4.7Kohm ,5% ,1/10W ,TP,1608	1
2007-000084	R523	R-CH P	4.7Kohm ,5% ,1/10W ,TP,1608	1
2007-000084	R524	R-CH P	4.7Kohm ,5% ,1/10W ,TP,1608	1
2007-000084	R525	R-CH P	4.7Kohm ,5% ,1/10W ,TP,1608	1
2007-000084	R526	R-CH P	4.7Kohm ,5% ,1/10W ,TP,1608	1

OUTDOOR MAIN PBA (DB92-02866A)

PartsCode	Design Loc	Description	Spec.	Q' TY
2007-000084	R527	R-CH P	4.7Kohm ,5% ,1/10W ,TP,1608	1
2007-000084	R534	R-CH P	4.7Kohm ,5% ,1/10W ,TP,1608	1
2007-000084	R535	R-CH P	4.7Kohm ,5% ,1/10W ,TP,1608	1
2007-000084	R536	R-CH P	4.7Kohm ,5% ,1/10W ,TP,1608	1
2007-000084	R903	R-CH P	4.7Kohm ,5% ,1/10W ,TP,1608	1
2007-000090	R301	R-CH P	10Kohm ,5% ,1/10W ,TP,1608	1
2007-000090	R302	R-CH P	10Kohm ,5% ,1/10W ,TP,1608	1
2007-000090	R304	R-CH P	10Kohm ,5% ,1/10W ,TP,1608	1
2007-000090	R305	R-CH P	10Kohm ,5% ,1/10W ,TP,1608	1
2007-000090	R528	R-CH P	10Kohm ,5% ,1/10W ,TP,1608	1
2007-000090	R532	R-CH P	10Kohm ,5% ,1/10W ,TP,1608	1
2007-000090	R533	R-CH P	10Kohm ,5% ,1/10W ,TP,1608	1
2007-000090	R551	R-CH P	10Kohm ,5% ,1/10W ,TP,1608	1
2007-000090	R552	R-CH P	10Kohm ,5% ,1/10W ,TP,1608	1
2007-000090	R553	R-CH P	10Kohm ,5% ,1/10W ,TP,1608	1
2007-000090	R554	R-CH P	10Kohm ,5% ,1/10W ,TP,1608	1
2007-000090	R555	R-CH P	10Kohm ,5% ,1/10W ,TP,1608	1
2007-000090	R559	R-CH P	10Kohm ,5% ,1/10W ,TP,1608	1
2007-000090	R565	R-CH P	10Kohm ,5% ,1/10W ,TP,1608	1
2007-000109	R531	R-CH P	1M ohm ,5% ,1/10W ,TP,1608	1
2007-000116	R306	R-CH P	120ohm ,5% ,1/10W ,TP,1608	1
2007-000124	R564	R-CH P	2.2Kohm ,5% ,1/10W ,TP,1608	1
2007-000140	R202	R-CH P	1Kohm ,5% ,1/16W ,TP,1005	1
2007-000140	R205	R-CH P	1Kohm ,5% ,1/16W ,TP,1005	1
2007-000143	R207	R-CH P	4.7Kohm ,5% ,1/16W ,TP,1005	1
2007-000143	R221	R-CH P	4.7Kohm ,5% ,1/16W ,TP,1005	1
2007-000143	R222	R-CH P	4.7Kohm ,5% ,1/16W ,TP,1005	1
2007-000143	R223	R-CH P	4.7Kohm ,5% ,1/16W ,TP,1005	1
2007-000143	R224	R-CH P	4.7Kohm ,5% ,1/16W ,TP,1005	1
2007-000143	R225	R-CH P	4.7Kohm ,5% ,1/16W ,TP,1005	1
2007-000143	R226	R-CH P	4.7Kohm ,5% ,1/16W ,TP,1005	1
2007-000143	R227	R-CH P	4.7Kohm ,5% ,1/16W ,TP,1005	1
2007-000143	R228	R-CH P	4.7Kohm ,5% ,1/16W ,TP,1005	1
2007-000143	R229	R-CH P	4.7Kohm ,5% ,1/16W ,TP,1005	1
2007-000143	R230	R-CH P	4.7Kohm ,5% ,1/16W ,TP,1005	1
2007-000143	R231	R-CH P	4.7Kohm ,5% ,1/16W ,TP,1005	1
2007-000143	R232	R-CH P	4.7Kohm ,5% ,1/16W ,TP,1005	1
2007-000148	R203	R-CH P	10Kohm ,5% ,1/16W ,TP,1005	1
2007-000148	R204	R-CH P	10Kohm ,5% ,1/16W ,TP,1005	1
2007-000148	R206	R-CH P	10Kohm ,5% ,1/16W ,TP,1005	1
2007-000170	R201	R-CH P	1M ohm ,5% ,1/16W ,TP,1005	1
2007-000239	R491	R-CH P	1.5Kohm ,1% ,1/10W ,TP,1608	1
2007-000256	R455	R-CH P	1.6Kohm ,1% ,1/10W ,TP,1608	1
2007-000256	R457	R-CH P	1.6Kohm ,1% ,1/10W ,TP,1608	1
2007-000256	R468	R-CH P	1.6Kohm ,1% ,1/10W ,TP,1608	1
2007-000300	R901	R-CH P	10Kohm ,5% ,1/8W ,TP,2012	1
2007-000385	R101	R-CH P	14.3Kohm ,1% ,1/4W ,TP,3216	1
2007-000385	R105	R-CH P	14.3Kohm ,1% ,1/4W ,TP,3216	1
2007-000455	R251	R-CH P	18Kohm ,1% ,1/10W ,TP,1608	1
2007-000455	R253	R-CH P	18Kohm ,1% ,1/10W ,TP,1608	1
2007-000491	R561	R-CH P	2.2Kohm ,1% ,1/10W ,TP,1608	1
2007-000536	R492	R-CH P	200ohm ,1% ,1/10W ,TP,1608	1
2007-000537	R154	R-CH P	200ohm ,1% ,1/4W ,TP,3216	1
2007-000537	R155	R-CH P	200ohm ,1% ,1/4W ,TP,3216	1
2007-000537	R156	R-CH P	200ohm ,1% ,1/4W ,TP,3216	1
2007-000537	R157	R-CH P	200ohm ,1% ,1/4W ,TP,3216	1
2007-000537	R158	R-CH P	200ohm ,1% ,1/4W ,TP,3216	1
2007-000614	R252	R-CH P	24Kohm ,1% ,1/10W ,TP,1608	1
2007-000614	R254	R-CH P	24Kohm ,1% ,1/10W ,TP,1608	1
2007-000614	R469	R-CH P	24Kohm ,1% ,1/10W ,TP,1608	1
2007-000614	R470	R-CH P	24Kohm ,1% ,1/10W ,TP,1608	1
2007-000614	R471	R-CH P	24Kohm ,1% ,1/10W ,TP,1608	1
2007-000614	R472	R-CH P	24Kohm ,1% ,1/10W ,TP,1608	1
2007-000614	R473	R-CH P	24Kohm ,1% ,1/10W ,TP,1608	1

OUTDOOR MAIN PBA (DB92-02866A)

PartsCode	Design Loc	Description	Spec.	Q' TY
2007-000614	R474	R-CH P	24Kohm ,1% ,1/10W ,TP,1608	1
2007-000651	R475	R-CH P	27Kohm ,1% ,1/10W ,TP,1608	1
2007-000683	R454	R-CH P	3.3Kohm ,1% ,1/10W ,TP,1608	1
2007-000683	R459	R-CH P	3.3Kohm ,1% ,1/10W ,TP,1608	1
2007-000683	R466	R-CH P	3.3Kohm ,1% ,1/10W ,TP,1608	1
2007-000763	R476	R-CH P	330ohm ,1% ,1/10W ,TP,1608	1
2007-000763	R477	R-CH P	330ohm ,1% ,1/10W ,TP,1608	1
2007-000872	R801	R-CH P	4.7Kohm ,5% ,1/8W ,TP,2012	1
2007-000872	R802	R-CH P	4.7Kohm ,5% ,1/8W ,TP,2012	1
2007-000872	R803	R-CH P	4.7Kohm ,5% ,1/8W ,TP,2012	1
2007-000924	R102	R-CH P	470Kohm ,1% ,1/4W ,TP,3216	1
2007-000924	R103	R-CH P	470Kohm ,1% ,1/4W ,TP,3216	1
2007-000924	R104	R-CH P	470Kohm ,1% ,1/4W ,TP,3216	1
2007-000924	R106	R-CH P	470Kohm ,1% ,1/4W ,TP,3216	1
2007-000924	R107	R-CH P	470Kohm ,1% ,1/4W ,TP,3216	1
2007-000924	R108	R-CH P	470Kohm ,1% ,1/4W ,TP,3216	1
2007-000979	R478	R-CH P	5.6Kohm ,1% ,1/10W ,TP,1608	1
2007-001071	R902	R-CH P	6.8Kohm ,5% ,1/8W ,TP,2012	1
2007-001175	R409	R-CH P	8.2Kohm ,1% ,1/10W ,TP,1608	1
2007-001175	R423	R-CH P	8.2Kohm ,1% ,1/10W ,TP,1608	1
2007-001175	R427	R-CH P	8.2Kohm ,1% ,1/10W ,TP,1608	1
2007-010245	R410	R-CH P	0.01ohm ,1% ,2W ,TP,6432	1
2007-010245	R411	R-CH P	0.01ohm ,1% ,2W ,TP,6432	1
2007-010245	R412	R-CH P	0.01ohm ,1% ,2W ,TP,6432	1
2007-010245	R425	R-CH P	0.01ohm ,1% ,2W ,TP,6432	1
2007-010245	R426	R-CH P	0.01ohm ,1% ,2W ,TP,6432	1
2201-000540	C425	C-CERAMIC, DISC	4. 7nF, 20%, 2000V, Y5U, 12x5mm, 10mm	1
2201-002002	C004	C-CERAMIC, DISC	4. 7nF, 20%, 400V, Y5U, 16x6mm, 10mm	1
2201-002002	C005	C-CERAMIC, DISC	4. 7nF, 20%, 400V, Y5U, 16x6mm, 10mm	1
2201-002002	C012	C-CERAMIC, DISC	4. 7nF, 20%, 400V, Y5U, 16x6mm, 10mm	1
2201-002002	C013	C-CERAMIC, DISC	4. 7nF, 20%, 400V, Y5U, 16x6mm, 10mm	1
2201-002427	C901	C-CERAMIC, DISC	2. 2nF, K (10%), 2000V, Y5P, 12. 5x5mm, 7. 5mm	1
2203-000236	C421	C-CER,CH P	0.1nF,5% ,50V,COG ,TP,1608	1
2203-000257	C222	C-CER,CH P	10nF,10% ,50V,X7R,TP,1608	1
2203-000257	C223	C-CER,CH P	10nF,10% ,50V,X7R,TP,1608	1
2203-000257	C224	C-CER,CH P	10nF,10% ,50V,X7R,TP,1608	1
2203-000257	C225	C-CER,CH P	10nF,10% ,50V,X7R,TP,1608	1
2203-000257	C301	C-CER,CH P	10nF,10% ,50V,X7R,TP,1608	1
2203-000257	C351	C-CER,CH P	10nF,10% ,50V,X7R,TP,1608	1
2203-000257	C352	C-CER,CH P	10nF,10% ,50V,X7R,TP,1608	1
2203-000257	C422	C-CER,CH P	10nF,10% ,50V,X7R,TP,1608	1
2203-000257	C423	C-CER,CH P	10nF,10% ,50V,X7R,TP,1608	1
2203-000440	C404	C-CER,CH P	1nF,10% ,50V,X7R,TP,1608	1
2203-000440	C405	C-CER,CH P	1nF,10% ,50V,X7R,TP,1608	1
2203-000440	C406	C-CER,CH P	1nF,10% ,50V,X7R,TP,1608	1
2203-000440	C408	C-CER,CH P	1nF,10% ,50V,X7R,TP,1608	1
2203-000440	C409	C-CER,CH P	1nF,10% ,50V,X7R,TP,1608	1
2203-000440	C410	C-CER,CH P	1nF,10% ,50V,X7R,TP,1608	1
2203-000440	C411	C-CER,CH P	1nF,10% ,50V,X7R,TP,1608	1
2203-000440	C501	C-CER,CH P	1nF,10% ,50V,X7R,TP,1608	1
2203-000440	C504	C-CER,CH P	1nF,10% ,50V,X7R,TP,1608	1
2203-000440	C505	C-CER,CH P	1nF,10% ,50V,X7R,TP,1608	1
2203-000440	C506	C-CER,CH P	1nF,10% ,50V,X7R,TP,1608	1
2203-000440	C507	C-CER,CH P	1nF,10% ,50V,X7R,TP,1608	1
2203-000440	C508	C-CER,CH P	1nF,10% ,50V,X7R,TP,1608	1
2203-000440	C510	C-CER,CH P	1nF,10% ,50V,X7R,TP,1608	1
2203-000440	C512	C-CER,CH P	1nF,10% ,50V,X7R,TP,1608	1
2203-000440	C523	C-CER,CH P	1nF,10% ,50V,X7R,TP,1608	1
2203-000440	C904	C-CER,CH P	1nF,10% ,50V,X7R,TP,1608	1
2203-000783	C455	C-CER,CH P	0.33nF,5% ,50V,COG ,TP,1608	1
2203-000783	C458	C-CER,CH P	0.33nF,5% ,50V,COG ,TP,1608	1
2203-002002	C453	C-CER,CH P	0.033nF,5% ,50V,NP0,TP,1608	1
2203-002002	C454	C-CER,CH P	0.033nF,5% ,50V,NP0,TP,1608	1
2203-002002	C459	C-CER,CH P	0.033nF,5% ,50V,NP0,TP,1608	1

OUTDOOR MAIN PBA (DB92-02866A)

Parts Code	Design Loc	Description	Spec.	Q' TY
2203-002002	C515	C-CER,CH P	0.033nF,5% ,50V,NP0,TP,1608	1
2203-002002	C516	C-CER,CH P	0.033nF,5% ,50V,NP0,TP,1608	1
2203-002002	C517	C-CER,CH P	0.033nF,5% ,50V,NP0,TP,1608	1
2203-002002	C518	C-CER,CH P	0.033nF,5% ,50V,NP0,TP,1608	1
2203-002002	C519	C-CER,CH P	0.033nF,5% ,50V,NP0,TP,1608	1
2203-002398	C524	C-CER,CH P	22nF,10% ,50V,X7R,TP,1608	1
2203-005249	C061	C-CER,CH P	100nF,10% ,50V,X7R,TP,1608	1
2203-005249	C151	C-CER,CH P	100nF,10% ,50V,X7R,TP,1608	1
2203-005249	C152	C-CER,CH P	100nF,10% ,50V,X7R,TP,1608	1
2203-005249	C153	C-CER,CH P	100nF,10% ,50V,X7R,TP,1608	1
2203-005249	C154	C-CER,CH P	100nF,10% ,50V,X7R,TP,1608	1
2203-005249	C162	C-CER,CH P	100nF,10% ,50V,X7R,TP,1608	1
2203-005249	C163	C-CER,CH P	100nF,10% ,50V,X7R,TP,1608	1
2203-005249	C220	C-CER,CH P	100nF,10% ,50V,X7R,TP,1608	1
2203-005249	C221	C-CER,CH P	100nF,10% ,50V,X7R,TP,1608	1
2203-005249	C251	C-CER,CH P	100nF,10% ,50V,X7R,TP,1608	1
2203-005249	C252	C-CER,CH P	100nF,10% ,50V,X7R,TP,1608	1
2203-005249	C253	C-CER,CH P	100nF,10% ,50V,X7R,TP,1608	1
2203-005249	C254	C-CER,CH P	100nF,10% ,50V,X7R,TP,1608	1
2203-005249	C302	C-CER,CH P	100nF,10% ,50V,X7R,TP,1608	1
2203-005249	C303	C-CER,CH P	100nF,10% ,50V,X7R,TP,1608	1
2203-005249	C304	C-CER,CH P	100nF,10% ,50V,X7R,TP,1608	1
2203-005249	C305	C-CER,CH P	100nF,10% ,50V,X7R,TP,1608	1
2203-005249	C306	C-CER,CH P	100nF,10% ,50V,X7R,TP,1608	1
2203-005249	C307	C-CER,CH P	100nF,10% ,50V,X7R,TP,1608	1
2203-005249	C401	C-CER,CH P	100nF,10% ,50V,X7R,TP,1608	1
2203-005249	C402	C-CER,CH P	100nF,10% ,50V,X7R,TP,1608	1
2203-005249	C403	C-CER,CH P	100nF,10% ,50V,X7R,TP,1608	1
2203-005249	C407	C-CER,CH P	100nF,10% ,50V,X7R,TP,1608	1
2203-005249	C420	C-CER,CH P	100nF,10% ,50V,X7R,TP,1608	1
2203-005249	C424	C-CER,CH P	100nF,10% ,50V,X7R,TP,1608	1
2203-005249	C460	C-CER,CH P	100nF,10% ,50V,X7R,TP,1608	1
2203-005249	C503	C-CER,CH P	100nF,10% ,50V,X7R,TP,1608	1
2203-005249	C509	C-CER,CH P	100nF,10% ,50V,X7R,TP,1608	1
2203-005249	C511	C-CER,CH P	100nF,10% ,50V,X7R,TP,1608	1
2203-005249	C514	C-CER,CH P	100nF,10% ,50V,X7R,TP,1608	1
2203-005249	C520	C-CER,CH P	100nF,10% ,50V,X7R,TP,1608	1
2203-005249	C521	C-CER,CH P	100nF,10% ,50V,X7R,TP,1608	1
2203-005249	C525	C-CER,CH P	100nF,10% ,50V,X7R,TP,1608	1
2203-005249	C526	C-CER,CH P	100nF,10% ,50V,X7R,TP,1608	1
2203-005249	C527	C-CER,CH P	100nF,10% ,50V,X7R,TP,1608	1
2203-005249	C701	C-CER,CH P	100nF,10% ,50V,X7R,TP,1608	1
2203-005249	C702	C-CER,CH P	100nF,10% ,50V,X7R,TP,1608	1
2203-005249	C703	C-CER,CH P	100nF,10% ,50V,X7R,TP,1608	1
2203-005249	C704	C-CER,CH P	100nF,10% ,50V,X7R,TP,1608	1
2203-005249	C903	C-CER,CH P	100nF,10% ,50V,X7R,TP,1608	1
2203-006158	C201	C-CER,CH P	100nF,10% ,16V,X7R,TP,1005,0.5T	1
2203-006158	C203	C-CER,CH P	100nF,10% ,16V,X7R,TP,1005,0.5T	1
2203-006158	C204	C-CER,CH P	100nF,10% ,16V,X7R,TP,1005,0.5T	1
2203-006158	C206	C-CER,CH P	100nF,10% ,16V,X7R,TP,1005,0.5T	1
2203-006158	C207	C-CER,CH P	100nF,10% ,16V,X7R,TP,1005,0.5T	1
2203-006158	C208	C-CER,CH P	100nF,10% ,16V,X7R,TP,1005,0.5T	1
2203-006158	C210	C-CER,CH P	100nF,10% ,16V,X7R,TP,1005,0.5T	1
2203-006158	C211	C-CER,CH P	100nF,10% ,16V,X7R,TP,1005,0.5T	1
2203-006158	C212	C-CER,CH P	100nF,10% ,16V,X7R,TP,1005,0.5T	1
2203-006460	C522	C-CER,CH P	2200nF,10% ,16V,X5R,TP,1608,-	1
2203-006960	C902	C-CER,CH P	1000nF,10% ,50V,X7R,TP,2012	1
2203-007456	C202	C-CER,CH P	1000nF,10% ,25V,X5R,TP,1005,0.5T	1
2203-007456	C205	C-CER,CH P	1000nF,10% ,25V,X5R,TP,1005,0.5T	1
2203-007456	C209	C-CER,CH P	1000nF,10% ,25V,X5R,TP,1005,0.5T	1
2203-007456	C213	C-CER,CH P	1000nF,10% ,25V,X5R,TP,1005,0.5T	1
2203-007456	C214	C-CER,CH P	1000nF,10% ,25V,X5R,TP,1005,0.5T	1
2203-007456	C226	C-CER,CH P	1000nF,10% ,25V,X5R,TP,1005,0.5T	1

OUTDOOR MAIN PBA (DB92-02866A)

Parts Code	Design Loc	Description	Spec.	Q' TY
2203-007456	C227	C-CER,CH P	1000nF,10% ,25V,X5R,TP,1005,0.5T	1
2203-007456	C228	C-CER,CH P	1000nF,10% ,25V,X5R,TP,1005,0.5T	1
2203-007456	C229	C-CER,CH P	1000nF,10% ,25V,X5R,TP,1005,0.5T	1
2301-001285	C001	C-FILM, LEAD-PPF	680nF, 10%, 275V, BK, 31x11x21mm	1
2301-001285	C006	C-FILM, LEAD-PPF	680nF, 10%, 275V, BK, 31x11x21mm	1
2306-000123	C412	C-FILM, LEAD-PPF	100nF, 5%, 630V, BK, 26x16. 5x8. 5mm	1
2401-000303	CE162	C-AL	100uF,20% ,25V,W T,TP,6.3x11m m ,5m m	1
2401-000303	CE163	C-AL	100uF,20% ,25V,W T,TP,6.3x11m m ,5m m	1
2401-001838	CE151	C-AL	470uF,20% ,25V,W T,TP,10x16,5m m	1
2401-002438	CE902	C-AL	47uF,20% ,50V,W T,TP,6.3x11,5m m	1
2401-003224	CE152	C-AL	470uF,20% ,16V,W T,TP,8x11.5,5m m	1
2401-003585	CE901	C-AL	220uF,20% ,35V,W T,TP,8x11.5m m ,5	1
2401-004874	CE101	C-AL	330uF,20% ,400V,BK,25.4*50,10m m	1
2401-004874	CE102	C-AL	330uF,20% ,400V,BK,25.4*50,10m m	1
2401-004874	CE103	C-AL	330uF,20% ,400V,BK,25.4*50,10m m	1
2402-001183	CE451	C-AL,SM D	220uF,20% ,16V,W T,TP,5.3X5.3X6M M	1
2402-001268	CE153	C-AL,SM D	100uF,20% ,25V,W T,TP,8x6.3m m	1
2402-001268	CE404	C-AL,SM D	100uF,20% ,25V,W T,TP,8x6.3m m	1
2402-001268	CE420	C-AL,SM D	100uF,20% ,25V,W T,TP,8x6.3m m	1
2402-001368	CE401	C-AL,SM D	47uF,20% ,25V,TP,6.3x4.9m m	1
2402-001368	CE402	C-AL,SM D	47uF,20% ,25V,TP,6.3x4.9m m	1
2402-001368	CE403	C-AL,SM D	47uF,20% ,25V,TP,6.3x4.9m m	1
2802-001165	X201	RESONATOR-CERAMIC	4MHz, 0. 5%, TP, 4. 5x2. 0x1. 15mm	1
2802-001211	X501	RESONATOR-CERAMIC	8MHZ, 0. 1%, TP, 3. 2X1. 3X0. 9 MM	1
3501-001154	RY022	RELAY-MINIATURE	12V, 200mW, 3000mA, 1FormA, 10ms, 10ms	1
3501-001154	RY030	RELAY-MINIATURE	12V, 200mW, 3000mA, 1FormA, 10ms, 10ms	1
3501-001279	RY021	RELAY-POWER	12V DC, 400mW, 16000mA, 1Form A, 15mS, 5mS	1
3601-001538	F001	FUSE-AXIAL LEAD	250V, 15A, TIME-LAG, CERAMIC, 6. 35x31. 8mm	1
3711-000015	CN203	HEADER-BOARD TO CABLE	BOX, 2P, 1R, 2. 5MM, STRAIGHT, SN, WHT	1
3711-000024	CN202	HEADER-BOARD TO CABLE	BOX, 3P, 1R, 2. 5MM, STRAIGHT, SN, WHT	1
3711-000177	CN301	HEADER-BOARD TO CABLE	1WALL, 2P, 1R, 3. 96MM, STRAIGHT, SN, RED	1
3711-000203	CN030	HEADER-BOARD TO CABLE	1WALL, 2P/3P, 1R, 7. 92mm, STRAIGHT, SN, WHT	1
3711-000296	CN901	HEADER-BOARD TO CABLE	1WALL, 6P, 1R, 3. 96MM, STRAIGHT, SN, WHT	1
3711-000760	CN551	HEADER-BOARD TO CABLE	BOX, 20P, 2R, 2MM, ANGLE, SN, BLK	1
3711-000879	CN152	HEADER-BOARD TO CABLE	BOX, 3P, 1R, 2. 5mm, STRAIGHT, SN, BLU	1
3711-000880	CN151	HEADER-BOARD TO CABLE	BOX, 3P, 1R, 2. 5MM, STRAIGHT, SN, RED	1
3711-000998	CN701	CONNECTOR-HEADER	BOX, 5P, 1R, 2. 5MM, STRAIGHT, SN, RED	1
3711-000999	CN204	HEADER-BOARD TO CABLE	BOX, 5P, 1R, 2. 5mm, STRAIGHT, SN, WHT	1
3711-002001	CN201	HEADER-BOARD TO CABLE	BOX, 20P, 2R, 2MM, STRAIGHT, SN, BLK	1
3711-003404	CN150	HEADER-BOARD TO CABLE	1WALL, 2P, 1R, 7. 92mm, STRAIGHT, SN, BLU	1
3711-003843	CN251	HEADER-BOARD TO CABLE	BOX, 8P, 1R, 2mm, STRAIGHT, SN, WHT	1
3711-007656	CN402	HEADER-BOARD TO CABLE	BOX, 3, 1R, 6mm, STRAIGHT, WHT	1
3711-007659	CN401	HEADER-BOARD TO CABLE	BOX, 2, 1R, 7. 92mm, STRAIGHT, WHT	1
3711-007817	CN501	HEADER-BOARD TO BOARD	3WALL, 7P, 1R, 2mm, STRAIGHT, SN, WHT	1
3712-001047	CN003	CONNECTOR-Term inal	TAB,M ALE,N,0.5/4.75m m	1
3712-001139	CN001	CONNECTOR-Term inal	TAB,M ALE,6.35x0.8m m	1
3712-001139	CN002	CONNECTOR-Term inal	TAB,M ALE,6.35x0.8m m	1
4715-001093	DSA001	SURGE ABSORBER	3600V,20% ,2000A,-AXIAL	1
4719-002483	PFC050	POWER MODULE	Smart Power Module, FPAB20BH60B, 600V, 20A, 89W, 20kHz, PFCM	1
4719-002484	IPM400	POWER MODULE	Smart Power Module, FNA41560B2, 600V, 15A, 41W, 20kHz	1
DB27-00097A	FT001	COIL CHOKE	CC-35-15SS, SI, 3. 5mH, +50~-30%, 15mohm Max, 15A, -25~+115	1
DB41-01227A	PCB MAIN	PCB MAIN	FR-4, 2Layer, 142*197, PF#2, OUTDOOR, 2oz, 142*197	1
DB61-05296A	SUPPORT-IC	SUPPORT-IC	AFX-HD 233A,PA66,FR50,BLACK	1
DB61-05916A	SUPPORT-PCB	SUPPORT-PCB	XS01_V2MD, HIPS, S834S1, 15. 5g, BLACK	1
DB91-01517A	IC501	ASSY MICOM	Soc 1Phase PF2, PF3, PF4, PF6, STM-125F-0A, HART-I910, 64LQFP, 64KB	ROM 1
0903-001843	-	IC-MICROCONTROLLER	HART-I910, LQFP, 64Z30, 12x12mm, 8MHz, 5V, 600mW, -40to+85C, 12KB, 64KB, Inverter SOC, Inverter SOC	1
DB91-01534A	IC201	ASSY MICOM	RAC A3050 Outdoor Micom, STM-130C-0S, S3FM02G, 128TQFP, ROM 384KB	1
DB09-00596A	-	IC MICOM	S3FM 02G,128PDC3V,TQFP,-40~+85,384K	1

6-4 ASSY WIFI PCB

■ ASSY WIFI PCB

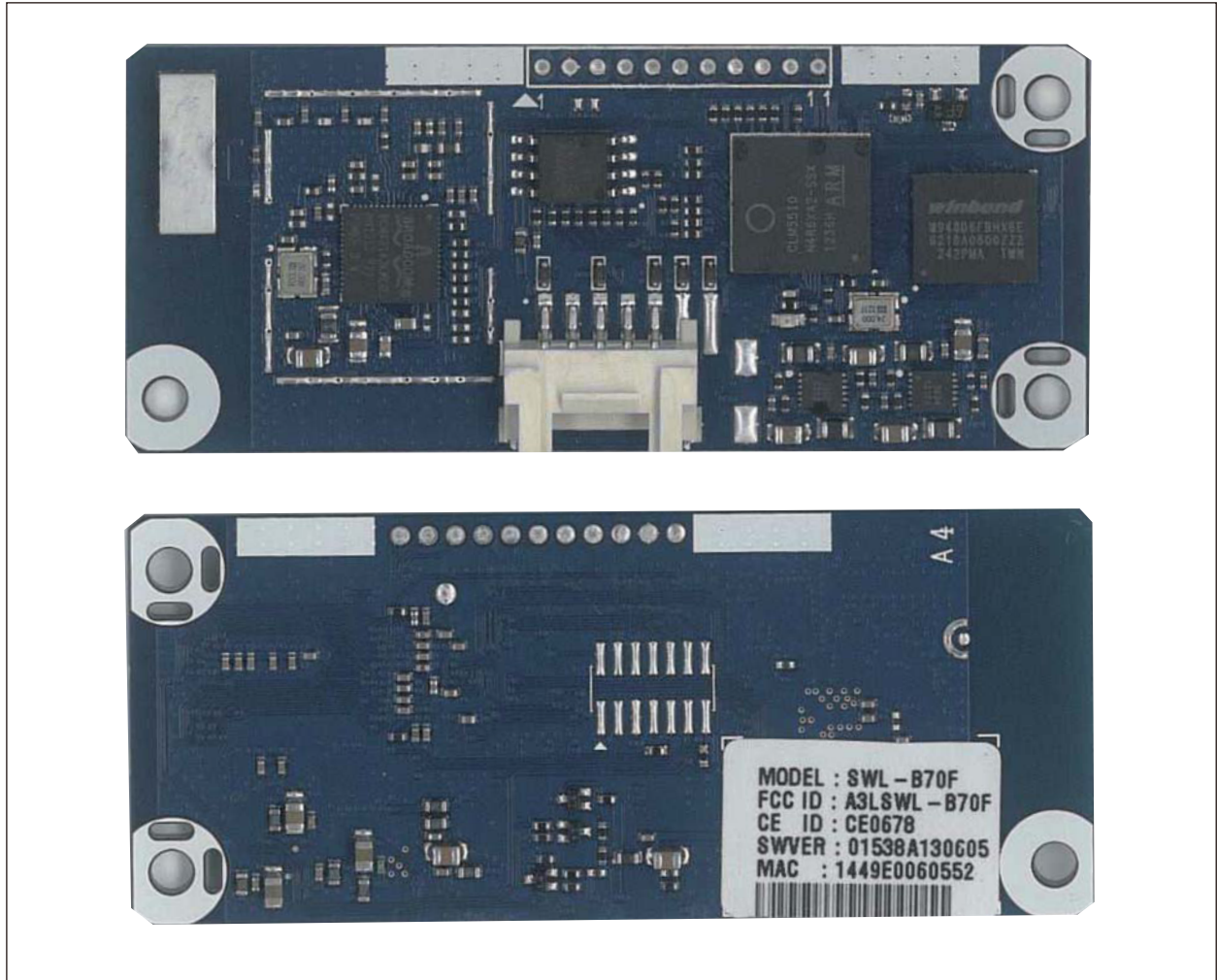

■ CONVERTER PBA

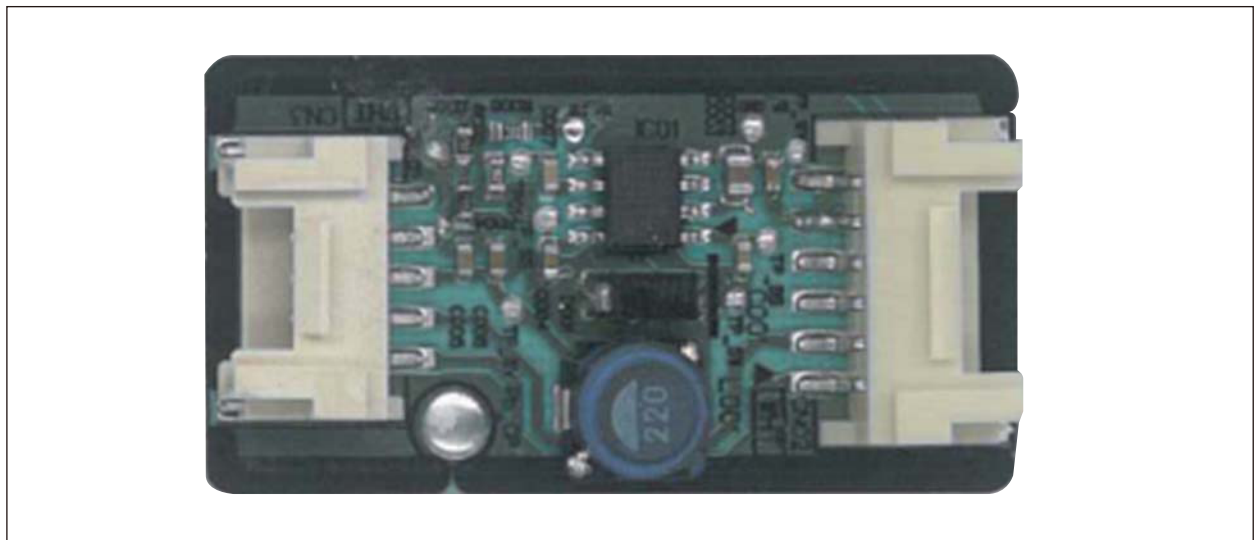

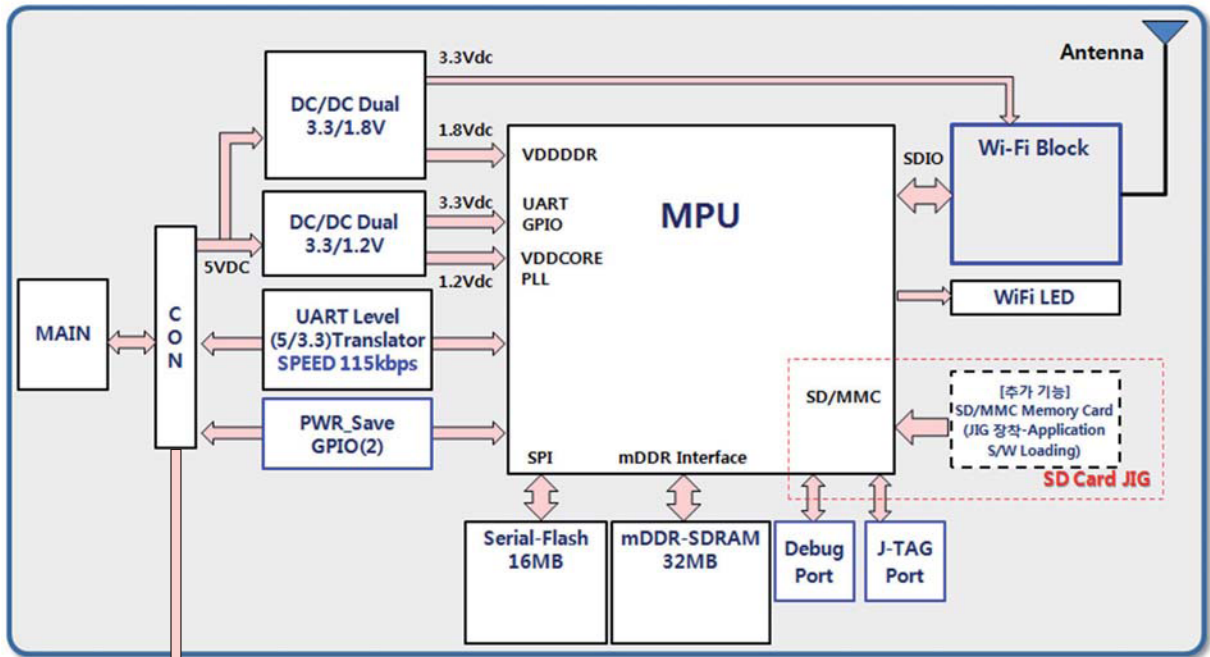

- 1 - nRST
- 2 - GND
- 3 - 5V
- 4 - UART RX
- 5 - UART TX

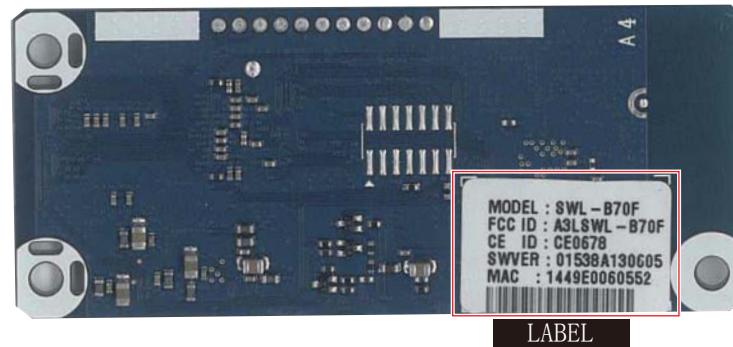
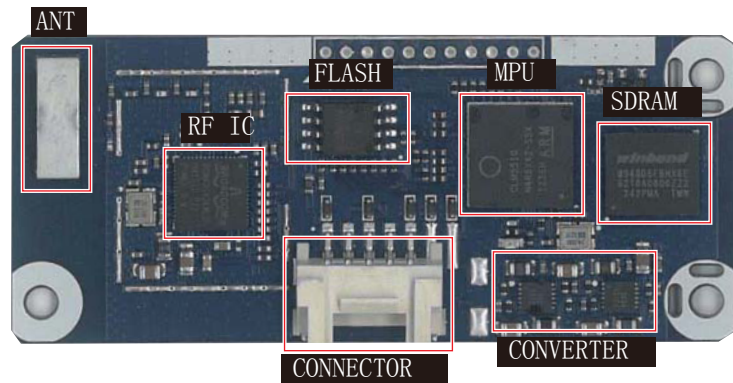

7. Wiring Diagram

7-1 Indoor Unit

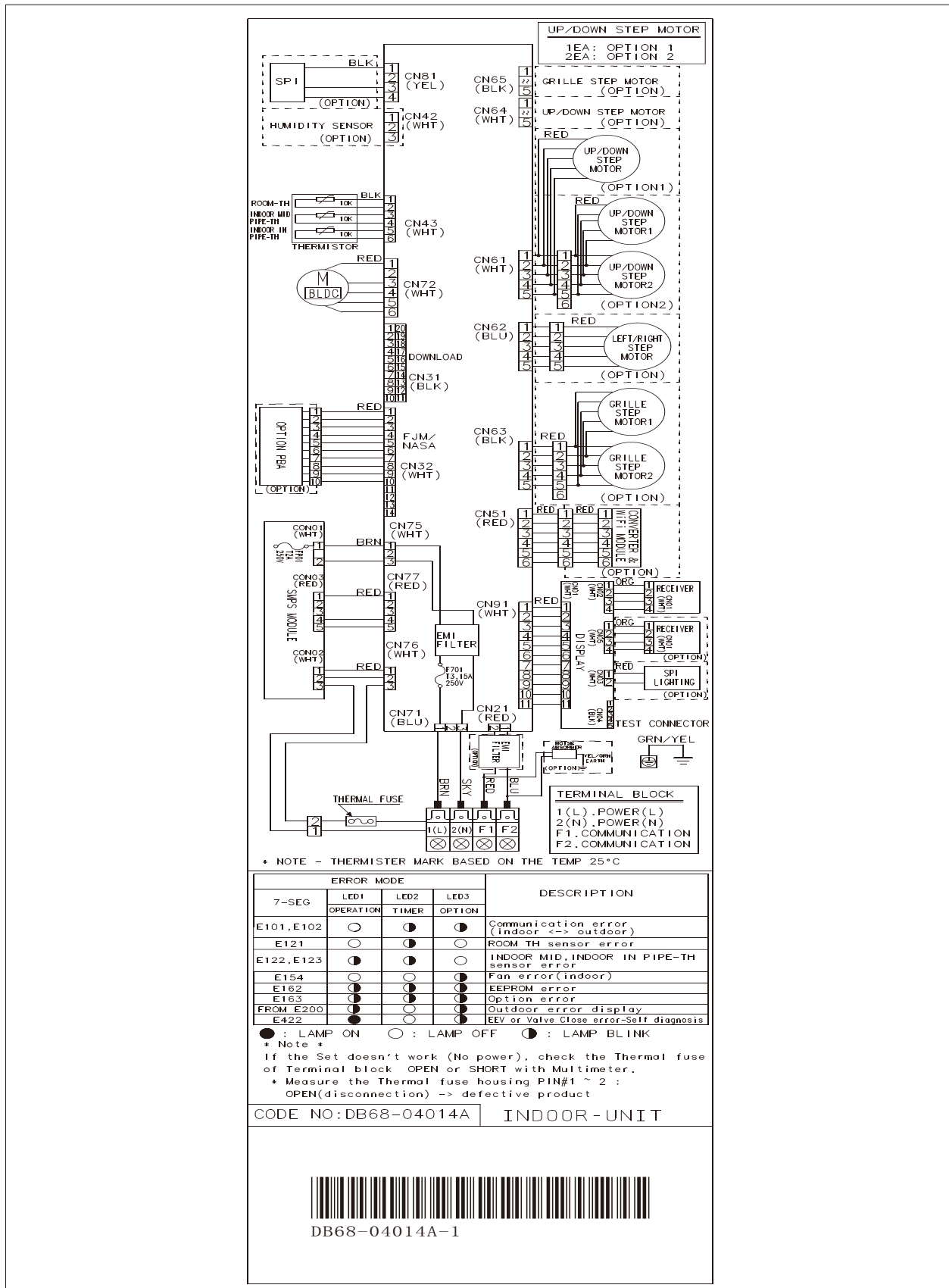

7-2 Outdoor Unit

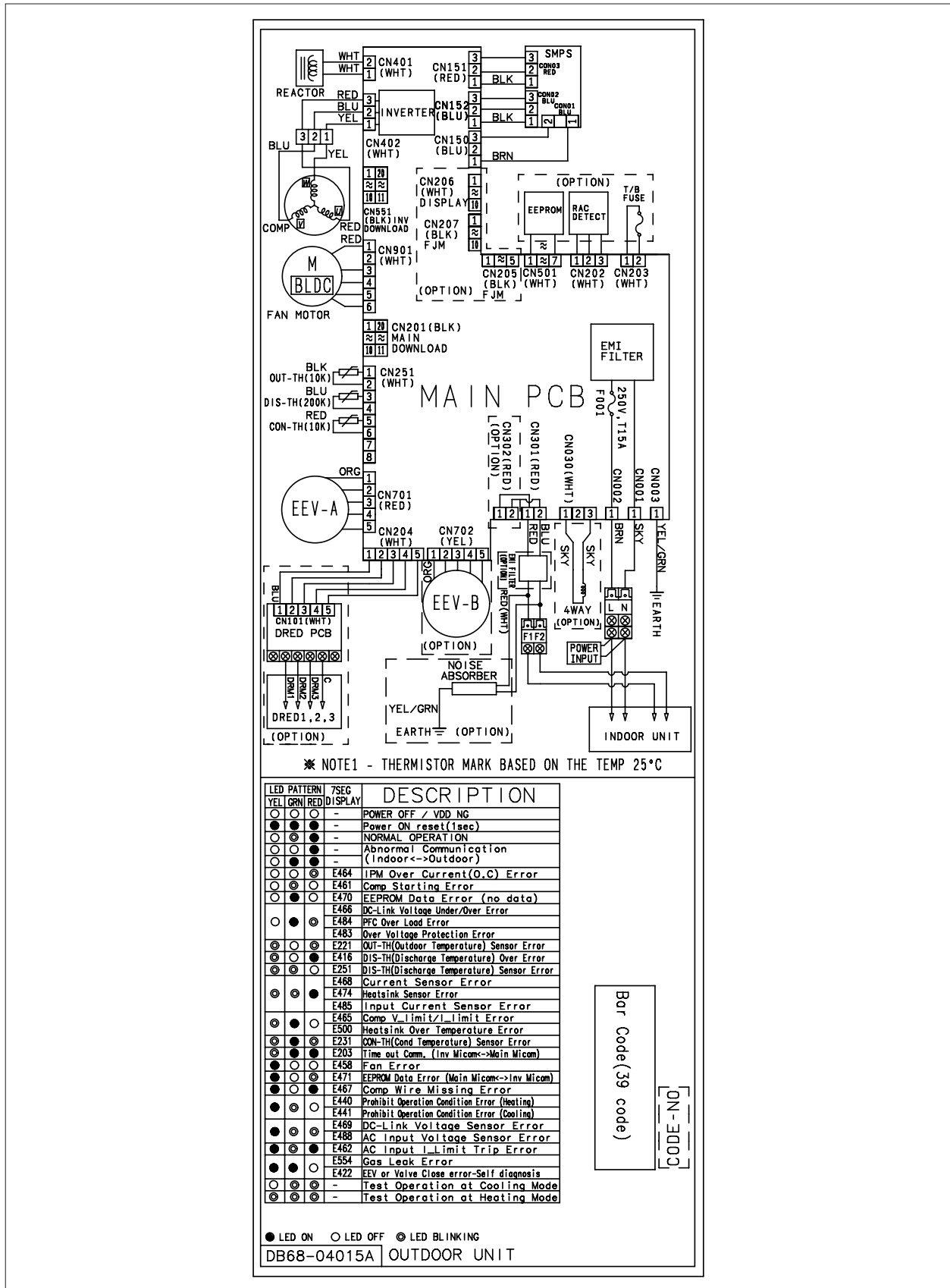

LED PATTERN	7SEC	DISPLAY	DESCRIPTION
○ ○ ○	-	-	POWER OFF / VDD NG
● ○ ○	-	-	Power ON reset(1sec)
○ ○ ○	-	-	NORMAL OPERATION
○ ○ ○	-	-	Abnormal Communication (Indoor<->Outdoor)
○ ○ ○	●	●	E464 IPM Over Current(O.C) Error
○ ○ ○	●	○	E461 Comp Starting Error
○ ○ ○	●	○	E470 EEPROM Data Error (no data)
○ ○ ○	●	○	E466 DC-Link Voltage Under/Over Error
○ ○ ○	●	○	E484 PFC Over Load Error
○ ○ ○	●	○	E483 Over Voltage Protection Error
○ ○ ○	●	○	E221 OUT-TH(Outdoor Temperature) Sensor Error
○ ○ ○	●	○	E416 DIS-TH(Discharge Temperature) Over Error
○ ○ ○	●	○	E251 DIS-TH(Discharge Temperature) Sensor Error
○ ○ ○	●	○	E468 Current Sensor Error
○ ○ ○	●	○	E474 Heatsink Sensor Error
○ ○ ○	●	○	E485 Input Current Sensor Error
○ ○ ○	●	○	E465 Comp V limit/L limit Error
○ ○ ○	●	○	E500 Heatsink Over Temperature Error
○ ○ ○	●	○	E231 CON-TH(Cond Temperature) Sensor Error
○ ○ ○	●	○	E203 Time out Comm. (Inv Micom->Main Micom)
○ ○ ○	●	○	E458 Fan Error
○ ○ ○	●	○	E471 EEPROM Data Error (Main Micom->Inv Micom)
○ ○ ○	●	○	E467 Comp Wire Missing Error
○ ○ ○	●	○	E440 Prohibit Operation Condition Error (Heating)
○ ○ ○	●	○	E441 Prohibit Operation Condition Error (Cooling)
○ ○ ○	●	○	E469 DC-Link Voltage Sensor Error
○ ○ ○	●	○	E488 AC Input Voltage Sensor Error
○ ○ ○	●	○	E462 AC Input I_Limit Trip Error
○ ○ ○	●	○	E554 Gas Leak Error
○ ○ ○	●	○	E422 EEV or Valve Close error-Self diagnosis
○ ○ ○	○	○	- Test Operation at Cooling Mode
○ ○ ○	○	○	- Test Operation at Heating Mode

Bar Code(39 code)
CODE NO

● LED ON ○ LED OFF ◎ LED BLINKING
DB68-04015A OUTDOOR UNIT

7-3 ASSY WIFI KIT

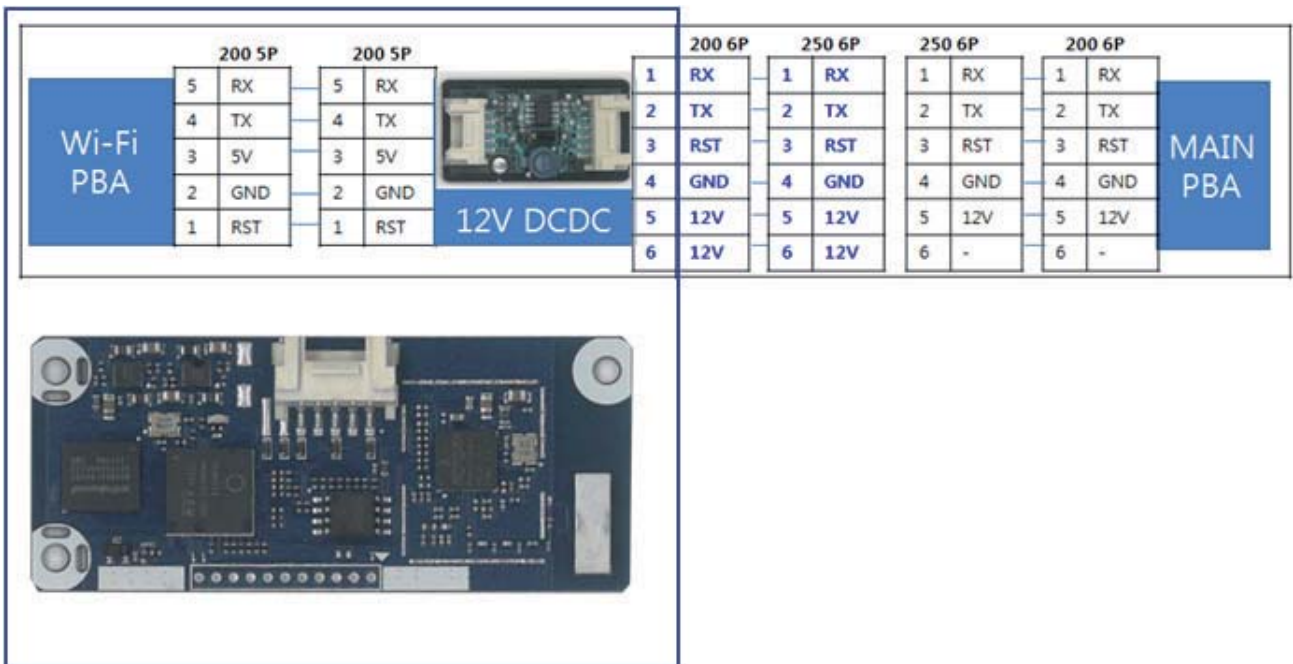
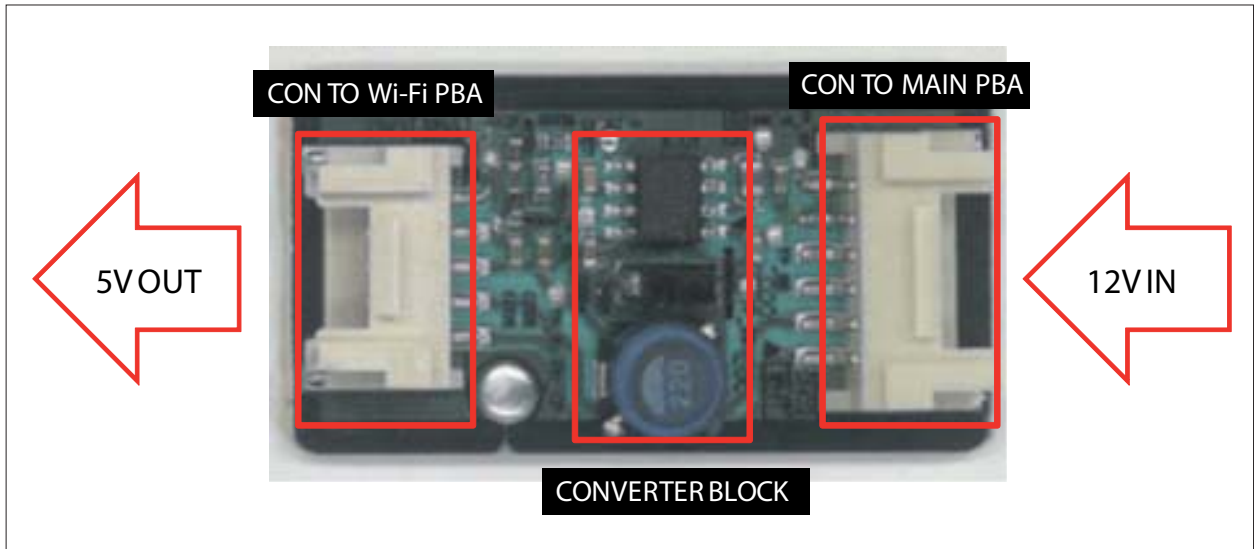
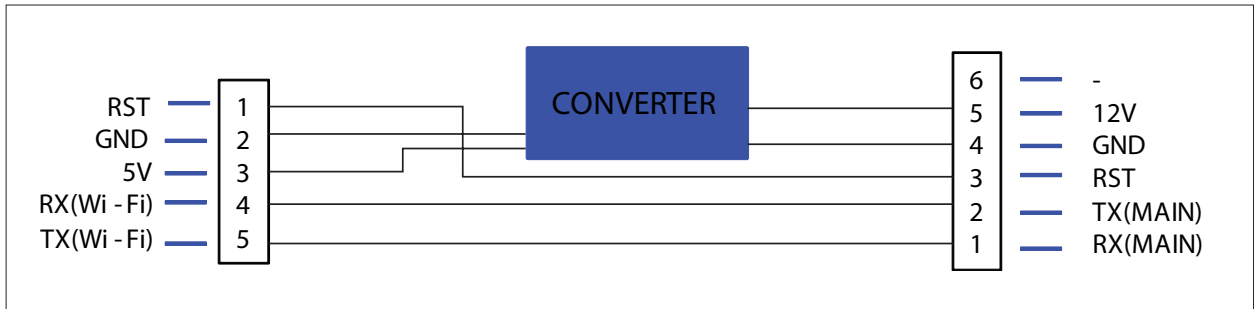

8. PCB Diagram

8-1 Indoor PCB

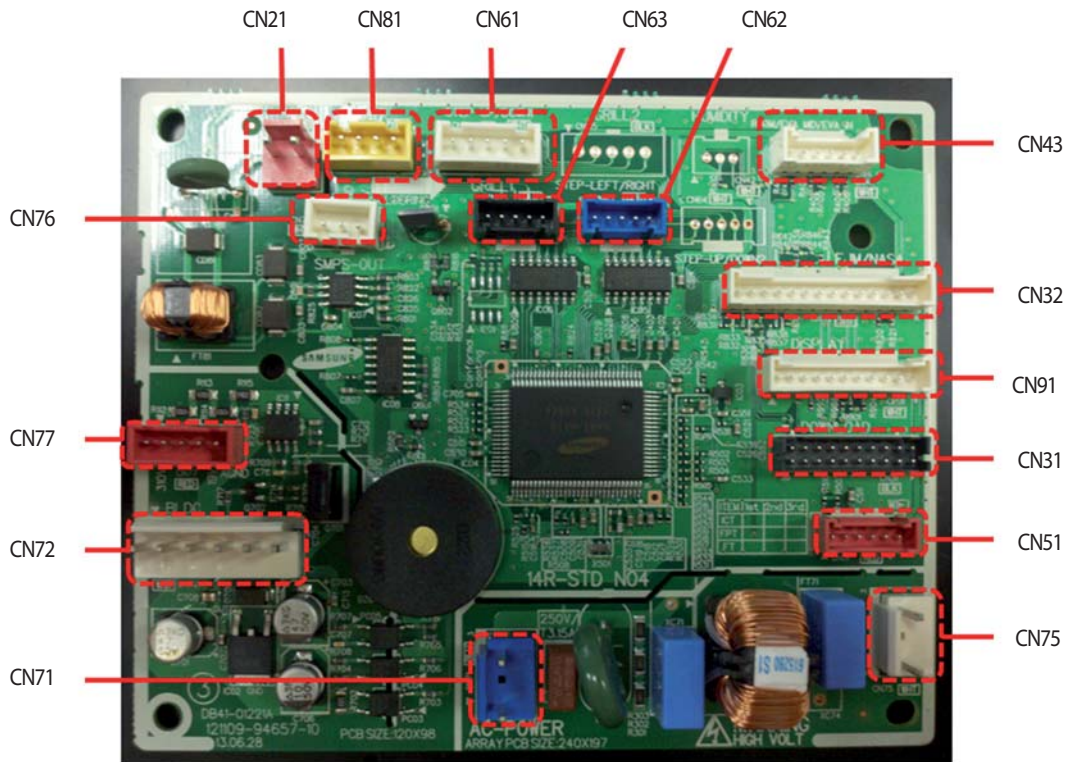

<p>① CN61/CN62/CN63 - STEP MOTOR</p> <p>#1: DC 12V #2~#5: STEP MOTOR SIGNAL</p>	<p>② CN71 - POWER IN</p> <p>#1,#3: AC220~240V #2: N.C</p>	<p>③ CN81 - SPI</p> <p>#1: SPI SIGNAL #3: DC 12V</p>	<p>④ CN51 - WI-FI MODULE</p> <p>#1: WIFI UART SIGNAL1 #2: WIFI UART SIGNAL2 #3: WIFI RESET SIGNAL #4: GND #5: DC 12V #6: N.C</p>
<p>⑤ CN51 - DISPLAY</p> <p>#1~#11,#14,#17~#20: MICOM DOWN #12, #13, #15, #16: N.C</p>	<p>⑥ CN43 - TEMPERATURE SENSOR</p> <p>#1,#2: ROOM SENSOR #3,#4: EVA MID SENSOR #5,#6: EVA IN SENSOR</p>	<p>⑦ CN21 - COMMUNICATION</p> <p>#1,#2: 485 COMM SIGNAL</p>	<p>⑧ CN72 - BLDC FAN MOTOR</p> <p>#1: DC 310~340V #2: N.C #3: AGND #4: DC 15V #5: FAN RPM #6: FAN FEEDBACK</p>
<p>⑨ CN32 - FJM/NASA</p> <p>#1~#7, #11~#14: FJM/NASA SIGNAL #8: DC 5V #9: GND #10: DC 12V</p>	<p>⑩ CN75 - SMPS POWER IN</p> <p>#1,#3: AC220~240V #2: N.C</p>	<p>⑪ CN76 - SMPS DC OUT (12V/GND/5V)</p> <p>#1: DC 5V #2: GND #3: DC 12V</p>	<p>⑫ CN77 - SMPS DC OUT (19V/GND/310V)</p> <p>#1: DC 310V~340V #2,#3: N.C #4: DC 19V~27V #5: AGND</p>
<p>⑬ CN31 - DOWNLOAD</p> <p>DOWNLOAD</p>			

8-2 Outdoor PCB

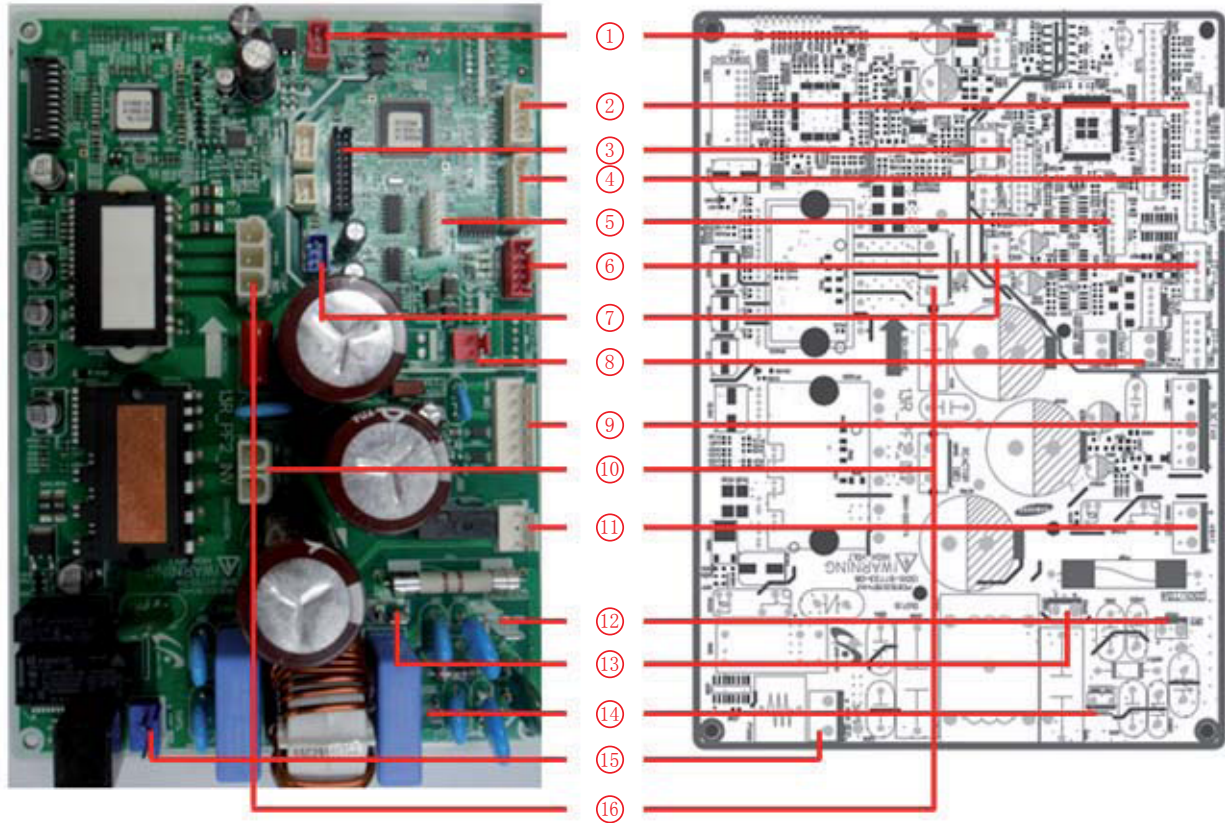

<p>① CN151 - SMPS INV</p> <p>#1 : 15V #2 : GND #3 : ENABLE</p>	<p>② CN204 - DRED</p> <p>#1 : DRED1 #2 : DRED2 #3 : DRED3 #4 : GND #5 : 5V</p>	<p>③ CN201 - DOWNLOAD-MAIN</p> <p>#1 ~ #20 : DOWNLAOD</p>	<p>④ CN251 - SENSOR</p> <p>#1, #2 : OUT SENSOR #3, #4 : DISCHARGE SENSOR #5, #6 : COND SENSOR</p>
<p>⑤ CN501 - EEPROM</p> <p>#1 : GND #3 : 5V #4 : EEP_CS #5 : EEP_SO/MICOM_RX #6 : EEP_SI_MICOM_TX #7 : EEP_CLK</p>	<p>⑥ CN701 - EEV-A</p> <p>#1~#4 : EEV SIGNAL #5 : 12V</p>	<p>⑦ CN152 - SMPS MAIN</p> <p>#1 : 12V #2 : GND #3 : 5V</p>	<p>⑧ CN301 - COMMUNICATION</p> <p>#1 : F1 #2 : F2</p>
<p>⑨ CN901 - FAN</p> <p>#1 : DC 310~340V #2 : N.C #3 : AGND #4 : DC 15V #5 : FAN RPM #6 : FAN FEEDBACK</p>	<p>⑩ CN401 - REACTOR</p> <p>#1 : REACTOR1 #2 : REACTOR2</p>	<p>⑪ CN030 - 4WAY</p> <p>#1, #3 : AC220~240V</p>	<p>⑫ CN001 - POWER-N</p> <p>#1 : N</p>
<p>⑬ CN002 - POWER-L</p> <p>#1 : L</p>	<p>⑭ CN003 - EARTH</p> <p>#1 : EARTH</p>	<p>⑮ CN150 - SMPS AC</p> <p>#1, #3 : AC220~240V</p>	<p>☒ CN402 - COMP</p> <p>#1 : W #2 : V #3 : U</p>

8-3 Wire connecting the indoor unit terminal blocks

1. Terminal press of Ring terminal shall be set facing up before connecting wire.



Is inverted



Terminal has been cut.

2. There shall be no empty space between Ring terminal and Screw after Clamp.
If not, there exists a possibility of fire which can be caused by electric heat in the connecting part.

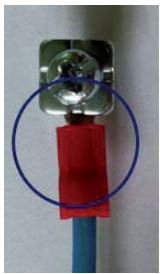

①



②



③

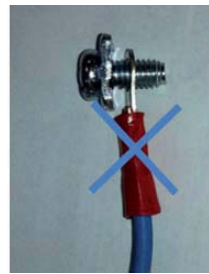

④



⑤



⑥

- ①, ② : Good
③ Bad : Ring terminal is connected reversely
④ Bad : Not clamped Screw
⑤ Bad : In the gap between Ring terminal & Screw
⑥ Bad : Unused Ring Terminal

9. Operating Instructions

9-1 Name of Each Part

9-1-1 Indoor Unit

The design and shape are subject to change according to the model.

■ Main Parts

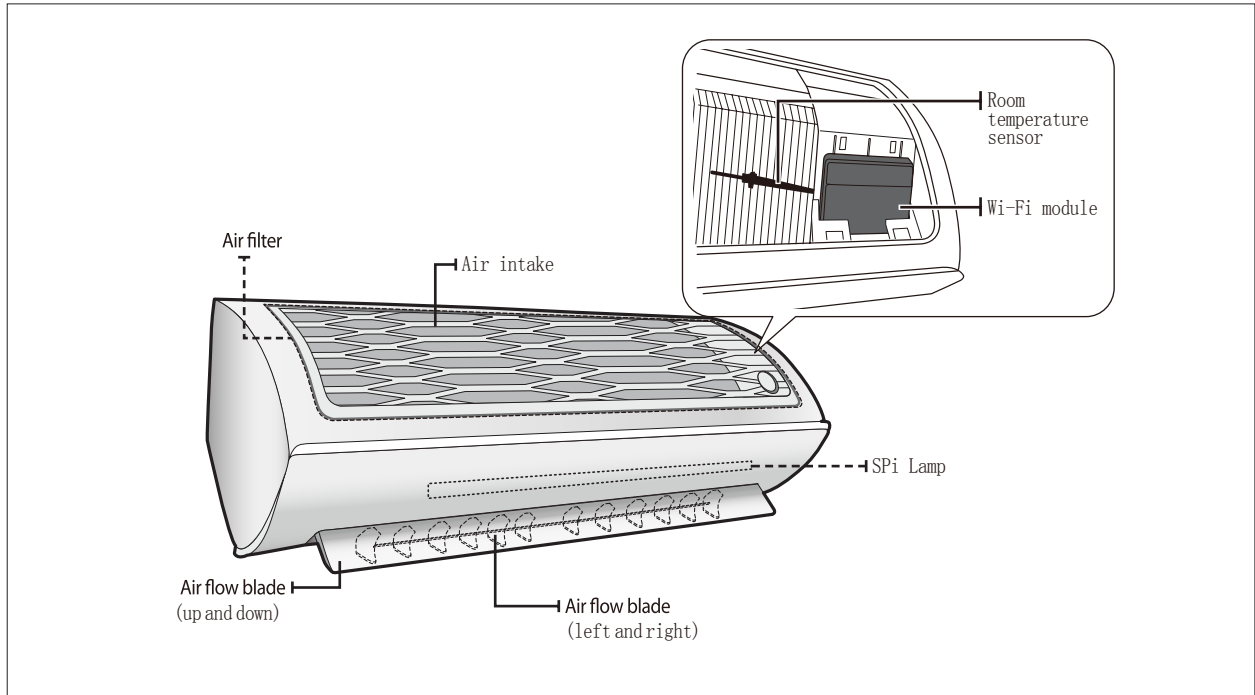

■ Display

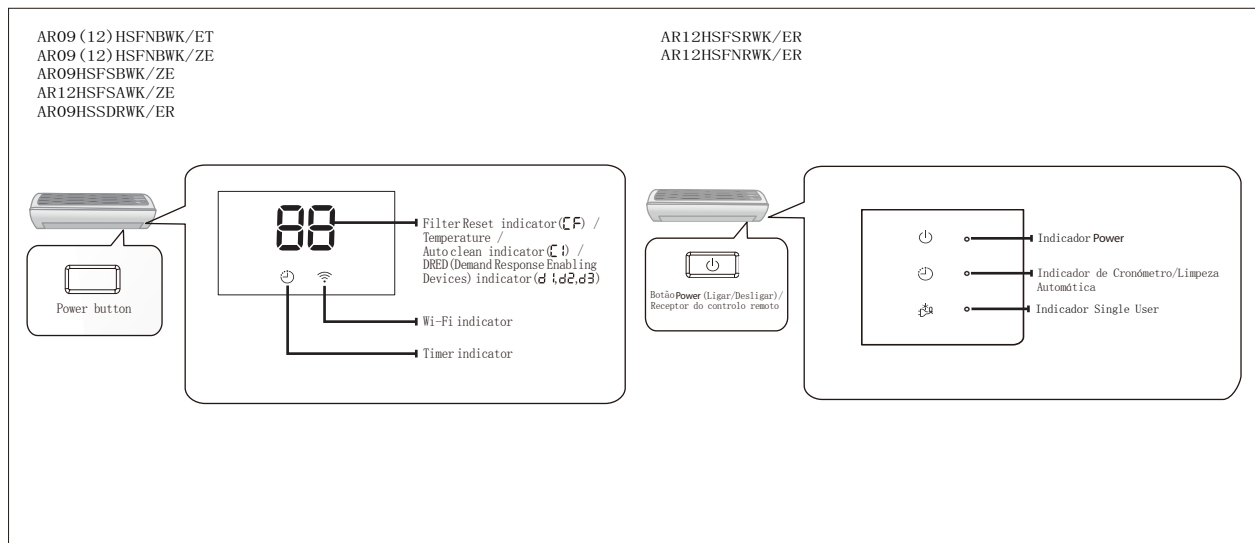

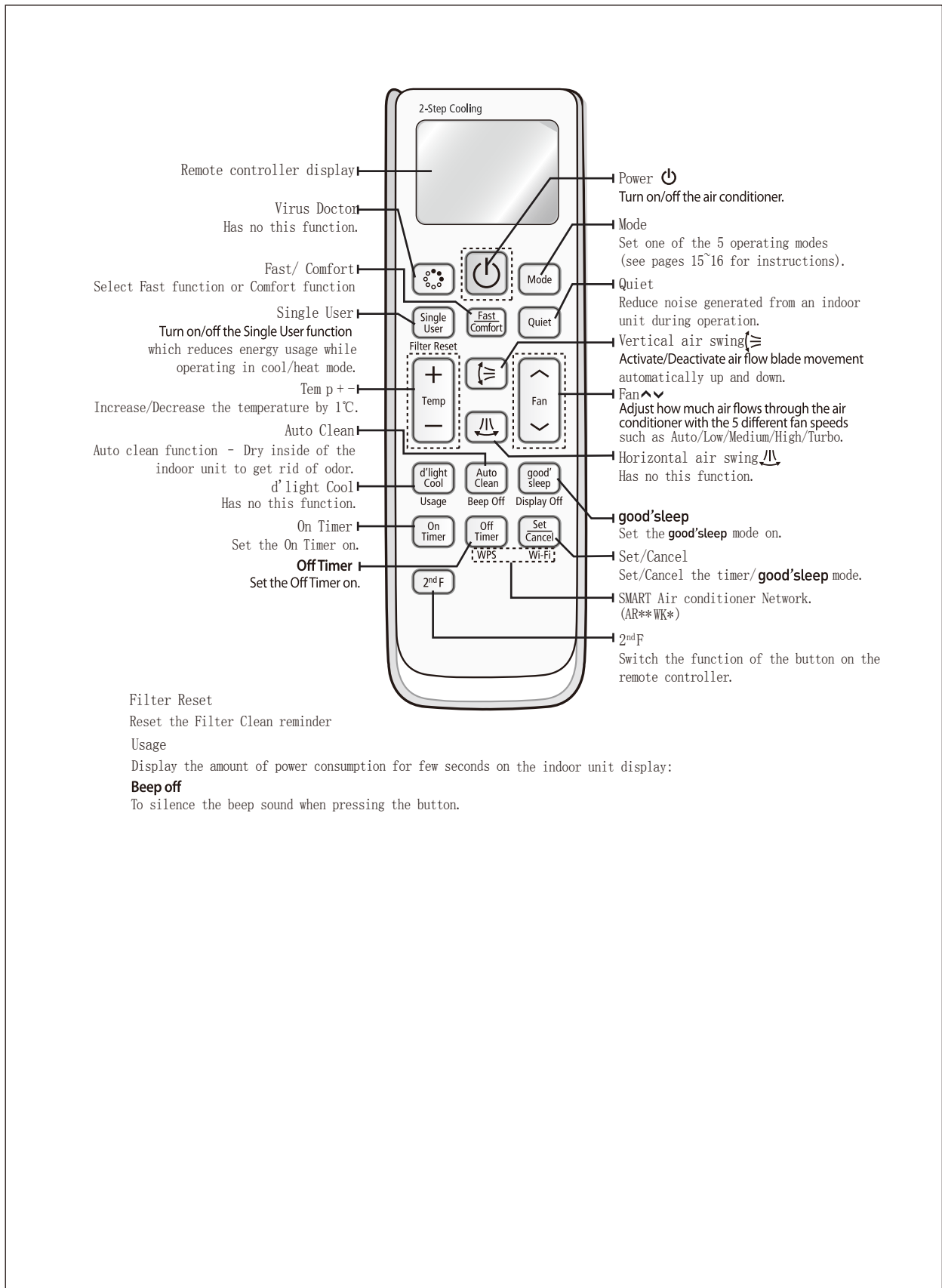

9-2 Wireless Remote Control-Buttons and Display



10. Troubleshooting

10-1 Items to be checked first

1. The input voltage should be rating voltage $\pm 10\%$ range.
The air conditioner may not operate properly if the voltage is out of this range.
2. Is the line cable linking the indoor unit and the outdoor unit linked properly?
The indoor unit and the outdoor unit shall be linked by 5 cables.
Check the terminals if the indoor unit and outdoor unit are properly linked by the same number of cables.
Otherwise the air conditioner may not operate properly.
3. When a problem occurs due to the contents illustrated in the table below it is a symptom not related to the malfunction of the air conditioner.

NO	Operation of air conditioner	Explanation
1	The OPERATION indication LED(BLUE) blinks when a power plug of the indoor unit is plugged in for first time.	It indicates power is on. The LED stops blinking if the operation ON/OFF button on the remote control unit is pushed.
2	In a COOL operation mode, the compressor does not operate at a room temperature higher than the setting temperature that the INDOOR FAN should operate. [In case of heat pump model] In a HEAT operation mode, the compressor does not operate at a room temperature lower than the setting temperature that indoor fan should operate.	In happens after a delay of 3 minutes when the compressor is reoperated. The same phenomenon occurs when a power is on. As a phenomenon that the compressor is reoperated after a delay of 3 minutes, the indoor fan is adjusted automatically with reference to a temperature of the air blew.
3	Fan speed setting is not allowed in DRY  mode.	The speed of the indoor fan is set to LL in DRY mode. Fan speed is selected automatically in AUTO mode.
4	Compressor stops operation intermittently in Dry  mode.	Compressor operation is controlled automatically in DRY mode depending on the room temperature and humidity.
5	Timer LED(ORANGE) of the indoor unit lights up and the air conditioner does not operate.	Timer is being activated and the unit is in ready mode. The unit operates normally if the timer operation is cancelled.
6	The compressor stops intermittently in a COOL mode or DRY mode, and fan speed of the indoor unit decreases.	The compressor stops intermittently or the fan speed of the indoor unit decreases to prevent inside/outside air frozen depending on the inside/outside air temperature.
7	[In case of heat pump model] Compressor of the outdoor unit is operating although it is turned off in a HEAT mode.	When the unit is turned off while de-ice is activated, the compressor continues operation for up to 9 minutes(maximum) until the deice is completed.
8	[In case of heat pump model] The compressor and indoor fan stop intermittently in HEAT mode.	The compressor and indoor fan stop intermittently if room temperature exceeds a setting temperature in order to protect the compressor from overheated air in a HEAT mode.
9	[In case of heat pump model] Indoor fan and outdoor fan stop operation intermittently in a HEAT mode.	The compressor operates in a reverse cycle to remove exterior ice in a HEAT mode, and indoor fan and outdoor fan do not operate intermittently for within 20% of the total heater operation.

10-2 Communication Error

10-2-1 Communication Error

Indoor display

3-LED DISPLAY			7-SEG DISPLAY	DESCRIPTION
LED1	LED2	LED3	E101/E102	Communication error(Indoor<->outdoor)
◎	●	●		

Outdoor display

◎	●	●	1min. Time out Comm.
○	○	●	Abnormal Communication
○	●	●	

● LED ON ◎ LED BLINKING ○ LED OFF

1. Checklist :

- 1) Is the cable between the indoor unit and outdoor unit connected correctly?
- 2) Isn't the power cable and communication cable cross?

2. Troubleshooting procedure

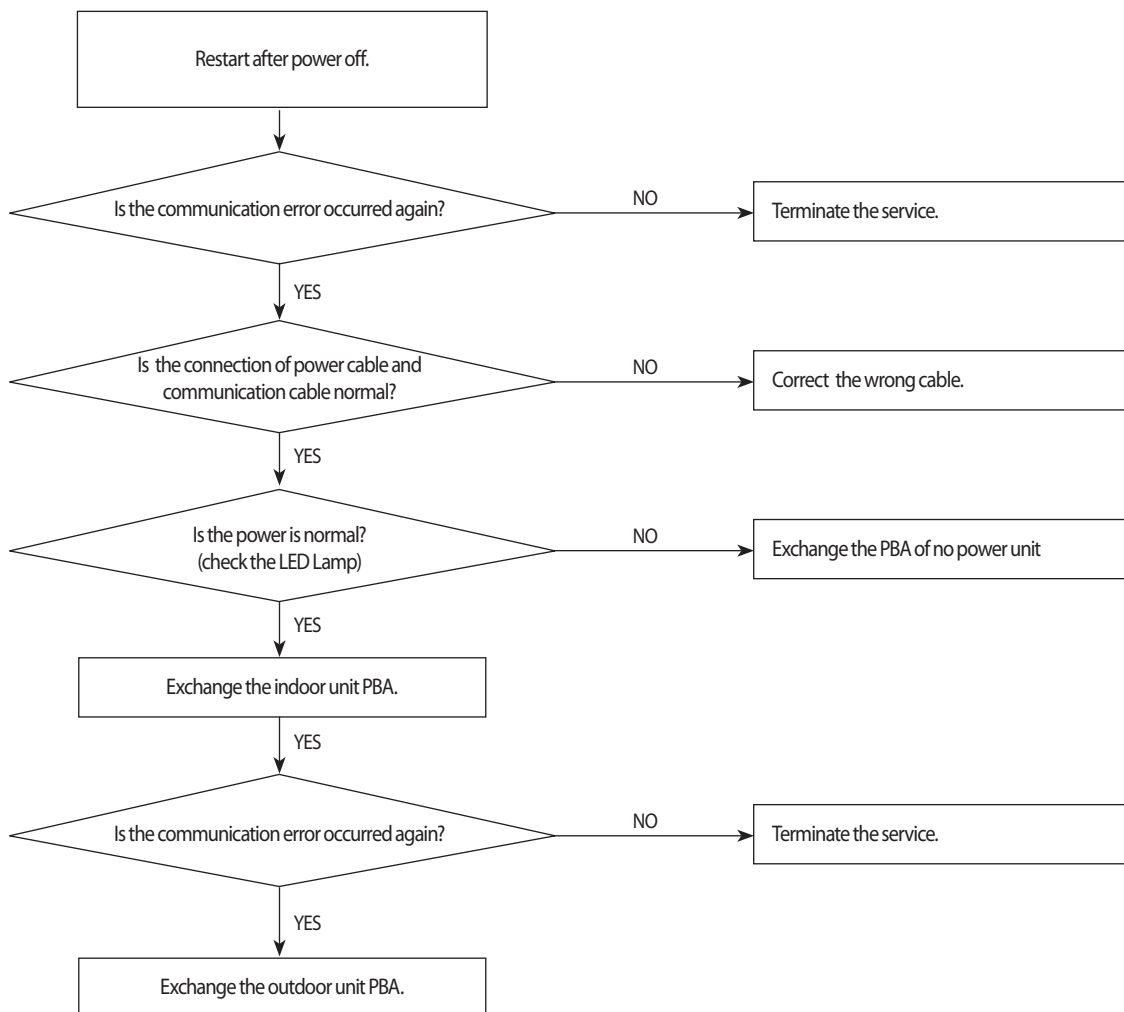

10-2-2 Indoor temperature sensor Error

Indoor display

7-SEG DISPLAY	DESCRIPTION
E121	Indoor room temp sensor error

1. Checklist :

- 1) Is the indoor units temperature sensor connected correctly?
- 2) Is the sensor placed correctly?
- 3) Does the both terminal of sensor satisfy the resistance value in accordance with temperature?

2. Troubleshooting procedure

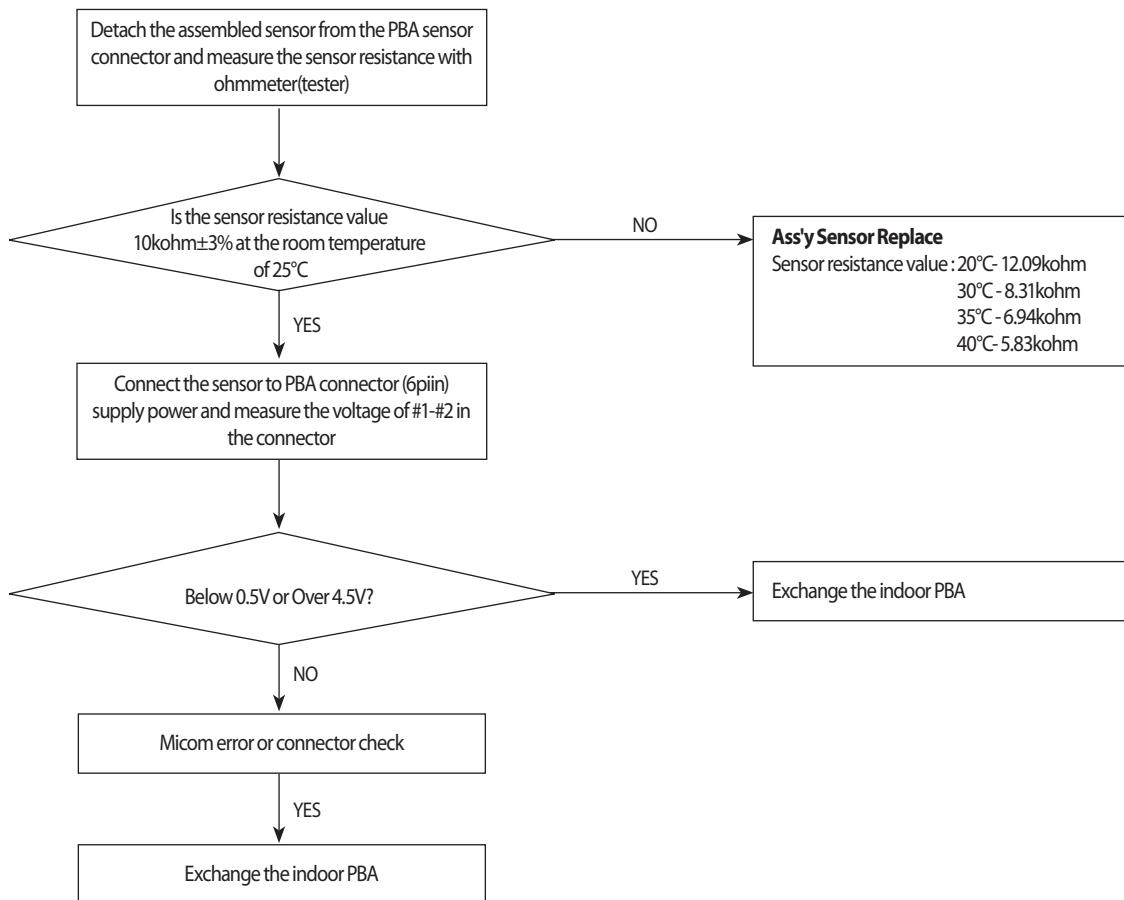

10-2-3 Indoor Eva-in temperature sensor error

Indoor display

3-LED DISPLAY			7-SEG DISPLAY	DESCRIPTION
LED1	LED2	LED3	E122,E123	Indoor MID, Indoor IN PIPE-TH sensor error
⊙	⊙	○		

● LED ON ⊙ LED BLINKING ○ LED OFF

1. Checklist :

- 1) Is the indoor units temperature sensor connected correctly?
- 2) Is the sensor placed correctly?
- 3) Does the both terminal of sensor satisfy the resistance value in accordance with temperature?

2. Troubleshooting procedure

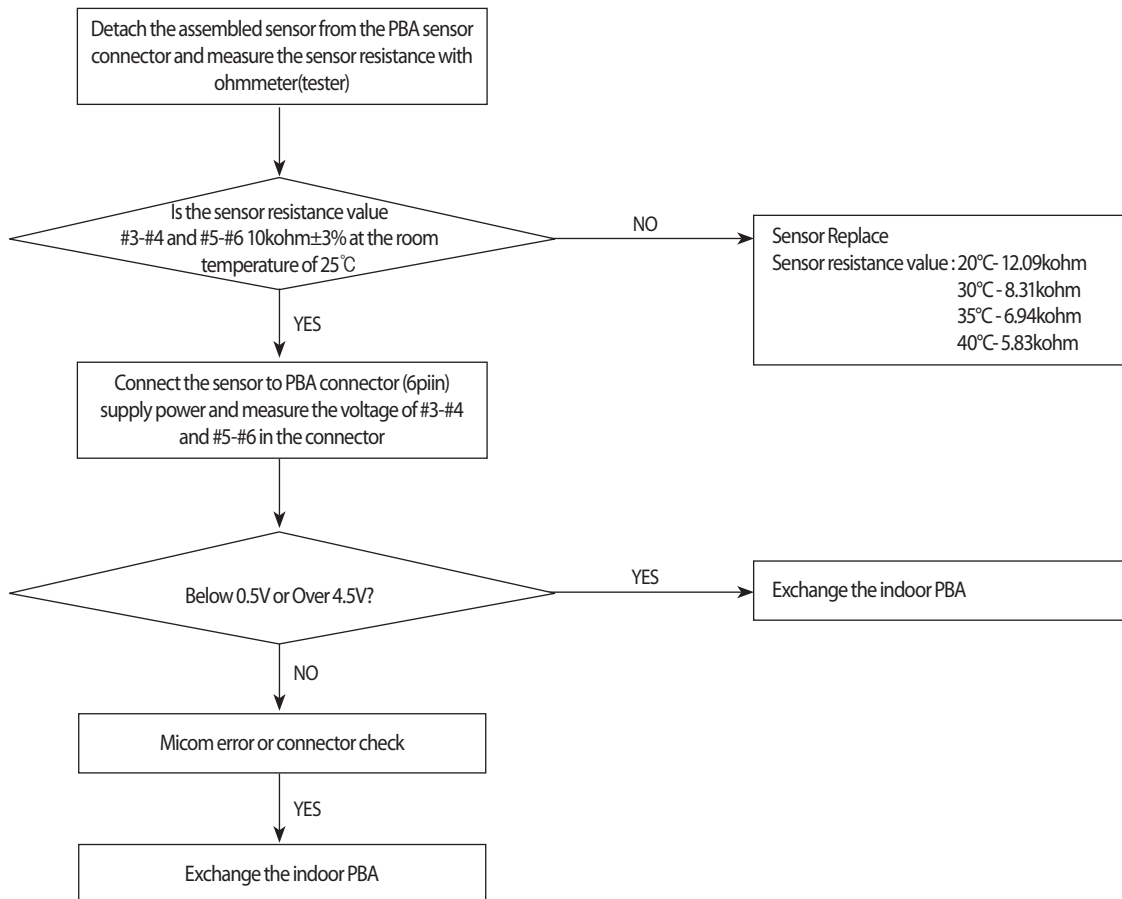

10-2-4 When the Up/Down, Left/Right, Grill louver motor does not operate (Initial Diagnosis) (Not displayed)

1. Checklist :

- 1) Is the input power voltage normal?
- 2) Is the Up/Down louver motor properly connected with the connector? (CN61, CN62, CN63)

2. Troubleshooting procedure

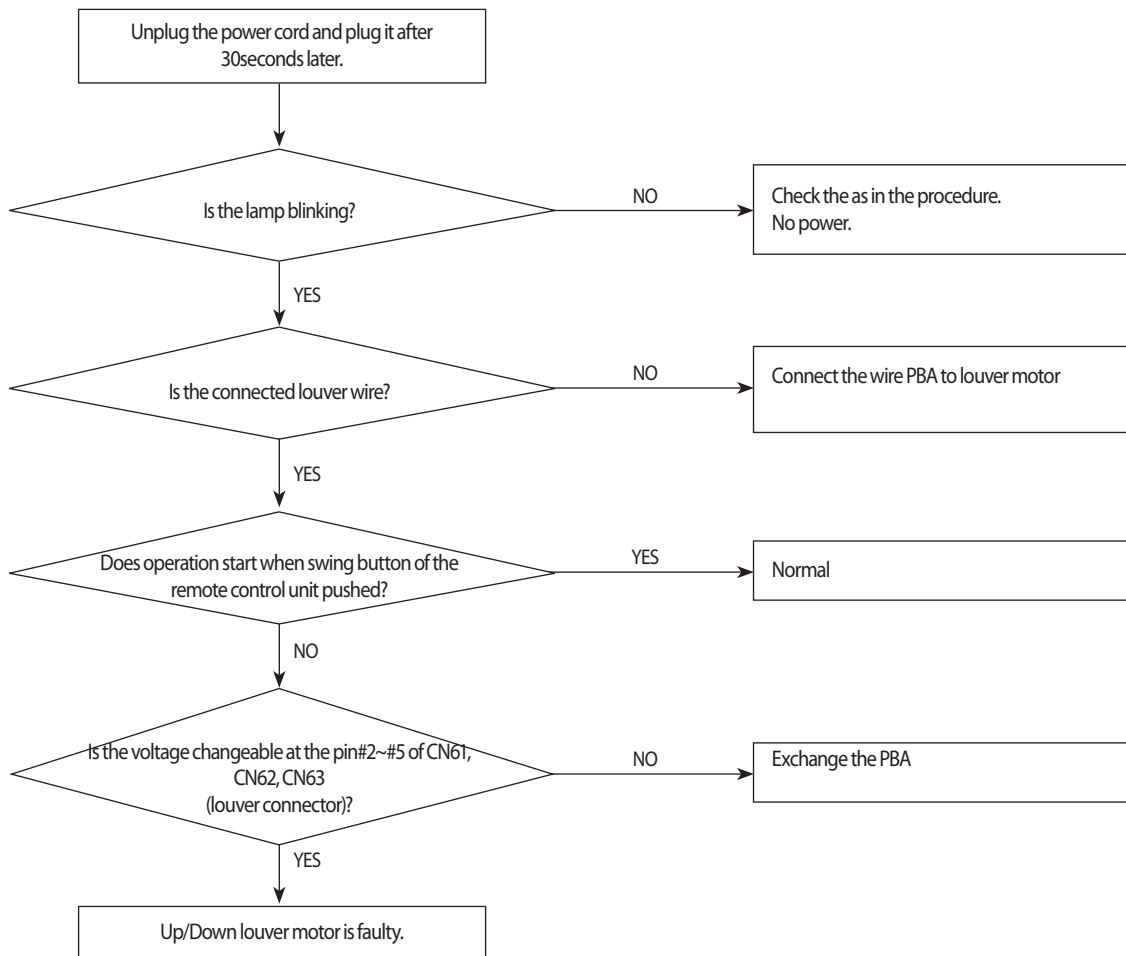

10-2-5 Indoor fan motor speed detecting error (BLDC fan)

Indoor display

3-LED DISPLAY			7-SEG DISPLAY	DESCRIPTION
LED1	LED2	LED3	E154	Indoor fan error
○	○	◎		

● LED ON ◎ LED BLINKING ○ LED OFF

1. Checklist :

- 1) Is the indoor units fan motor properly connected with the connector(CN72)?
- 2) Is the AC voltage correct?

2. Troubleshooting procedure

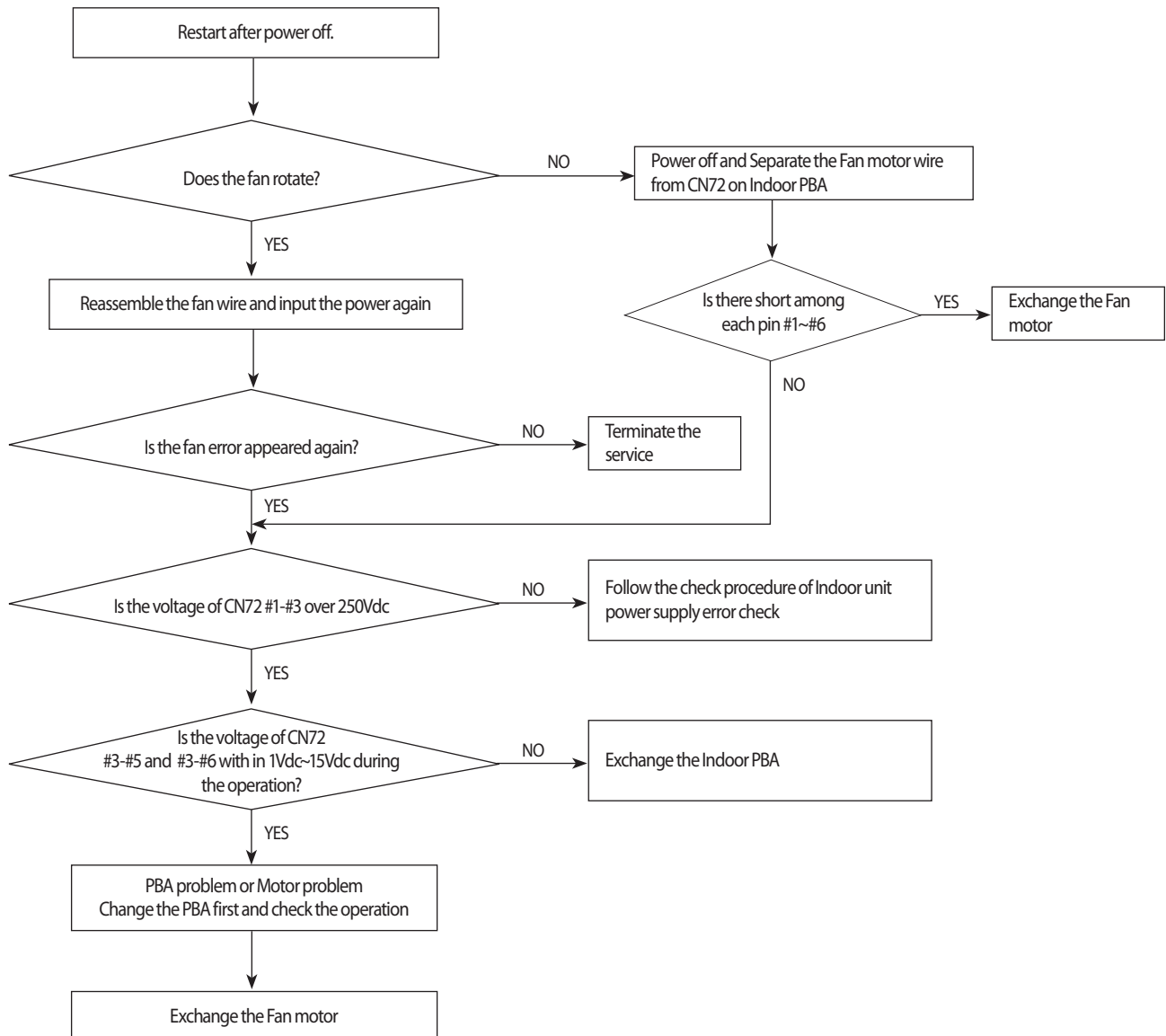

10-2-6 Outdoor temperature sensor error

Indoor display

3-LED DISPLAY			7-SEG DISPLAY	DESCRIPTION
LED1	LED2	LED3	E221	Outdoor temperature sensor error
⊙	○	⊙		

Outdoor display

⊙	○	⊙	Outdoor temperature sensor error
---	---	---	----------------------------------

● LED ON ⊙ LED BLINKING ○ LED OFF

1. Checklist :

- 1) Is the sensor connected correctly?
- 2) Is the sensor placed correctly?
- 3) Does the both terminal of sensor satisfy the resistance value in accordance with temperature?
- 4) Is the resistance value of sensor connection pull-up correct?

MODEL	"A"	"B"
ALL	CN251	CN251 #1-#2

2. Troubleshooting procedure

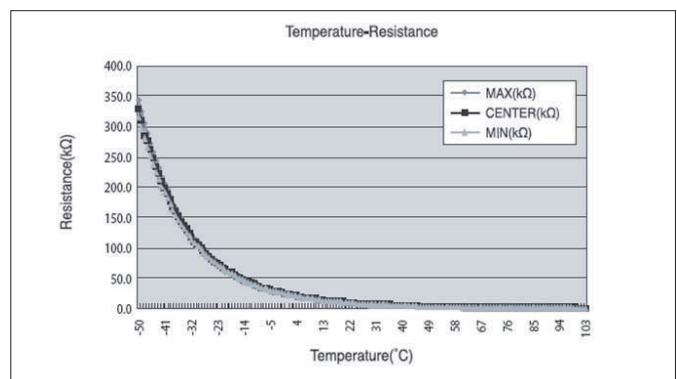
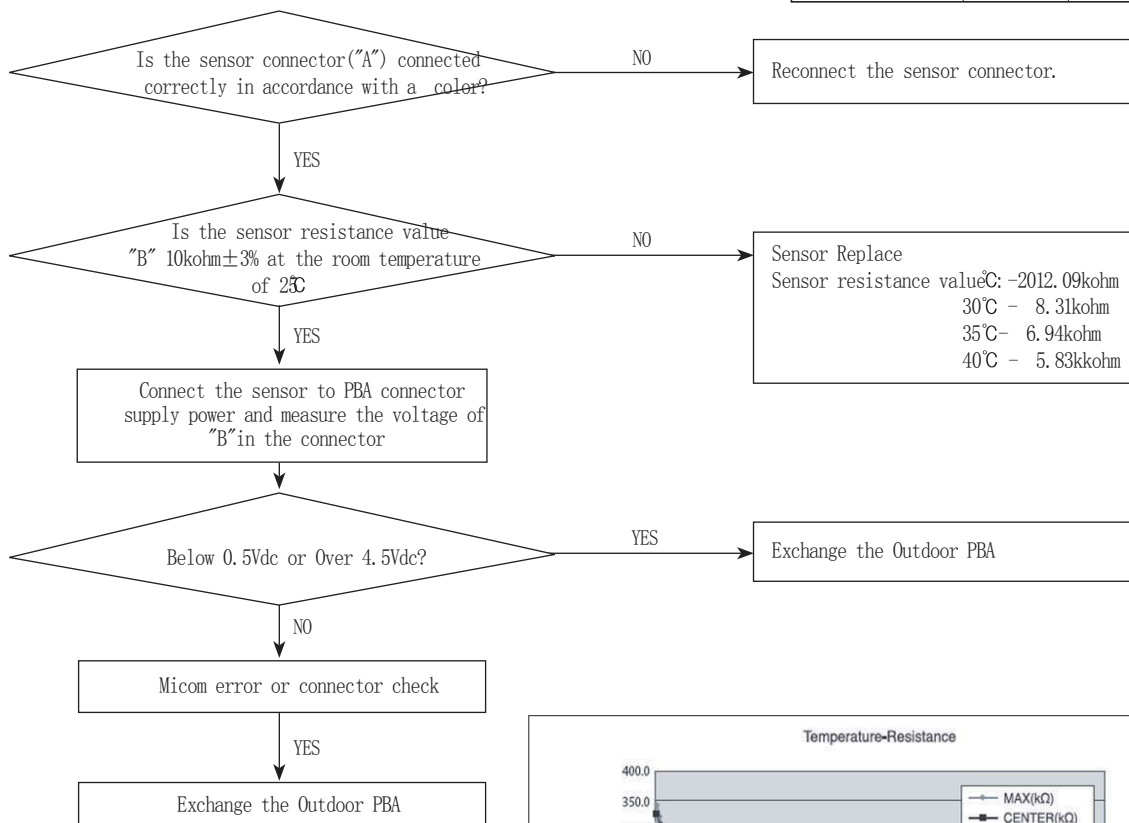

10-2-7 Outdoor Cond temperature sensor error

Indoor display

3-LED DISPLAY			7-SEG DISPLAY	DESCRIPTION
LED1	LED2	LED3	E231	Outdoor Cond temperature sensor error
⊙	○	⊙		

Outdoor display

⊙	●	⊙	Outdoor Cond temperature sensor error
---	---	---	---------------------------------------

● LED ON ⊙ LED BLINKING ○ LED OFF

1. Checklist :

- 1) Is the sensor connected correctly?
- 2) Is the sensor placed correctly?
- 3) Does the both terminal of sensor satisfy the resistance value in accordance with temperature?
- 4) Is the resistance value of sensor connection pull-up correct?

MODEL	"A"	"B"
ALL	CN251	CN251 #5-#6

2. Troubleshooting procedure

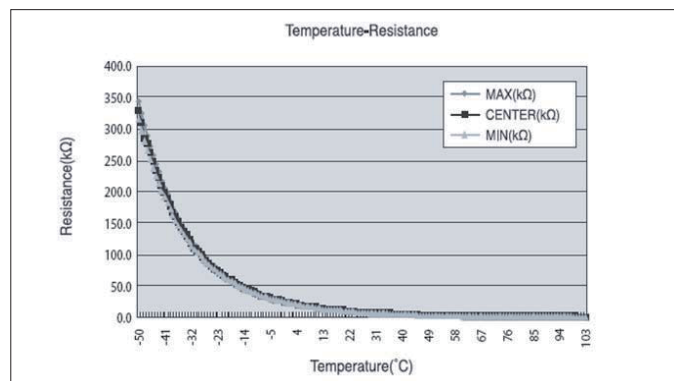
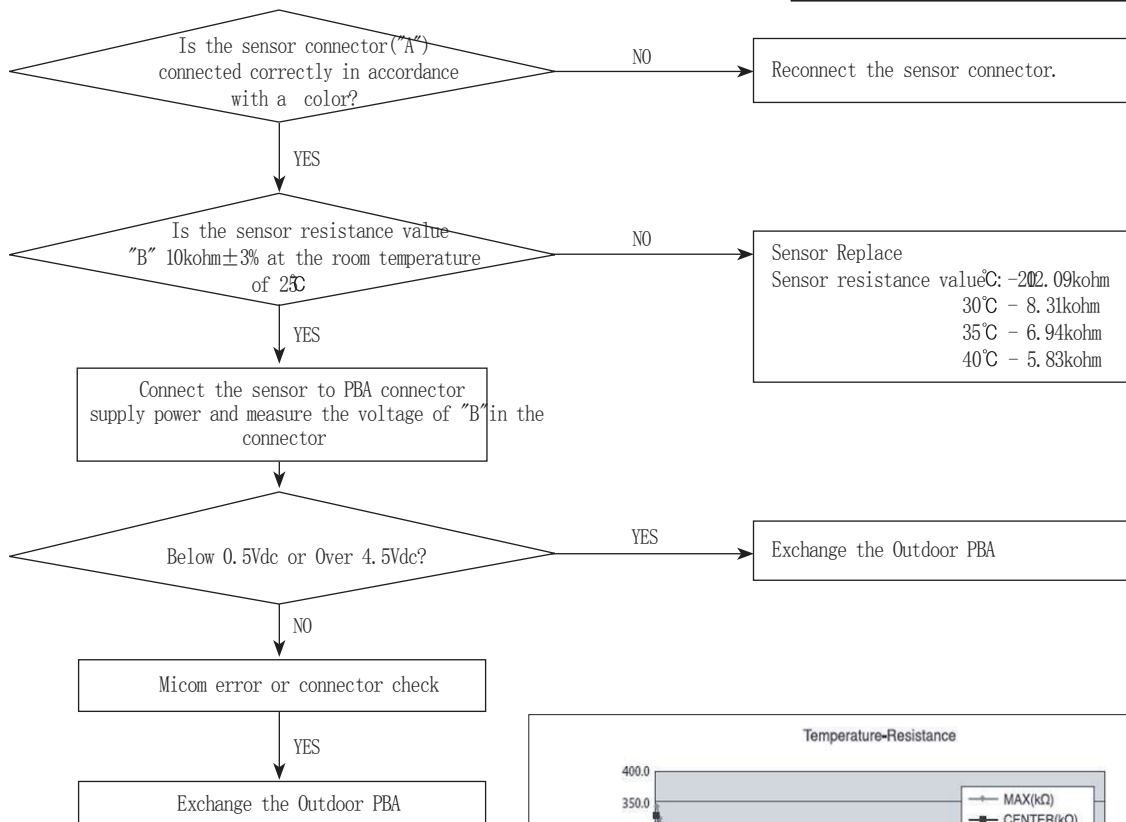

10-2-8 Outdoor Discharge temperature sensor error

Indoor display

3-LED DISPLAY			7-SEG DISPLAY	DESCRIPTION
LED1	LED2	LED3	E251	Outdoor Discharge temperature sensor error
⊙	○	⊙		

Outdoor display

⊙	⊙	○	Outdoor Discharge temperature sensor error
---	---	---	--

● LED ON ⊙ LED BLINKING ○ LED OFF

1. Checklist :

- 1) Is the sensor connected correctly?
- 2) Is the sensor placed correctly?
- 3) Does the both terminal of sensor satisfy the resistance value in accordance with temperature?
- 4) Is the resistance value of sensor connection pull-up correct?

MODEL	"A"	"B"
ALL	CN251	CN251 #3-#4

2. Troubleshooting procedure

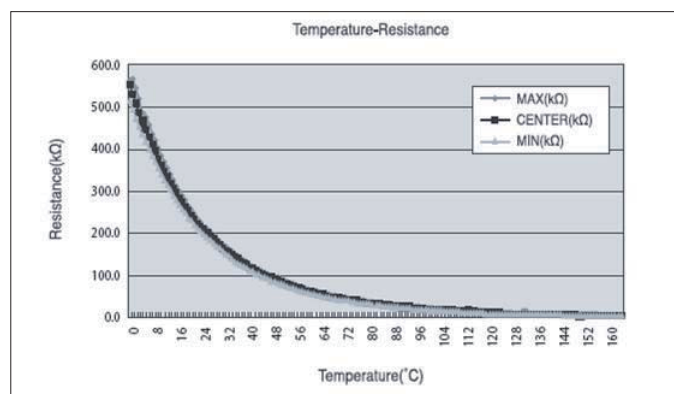
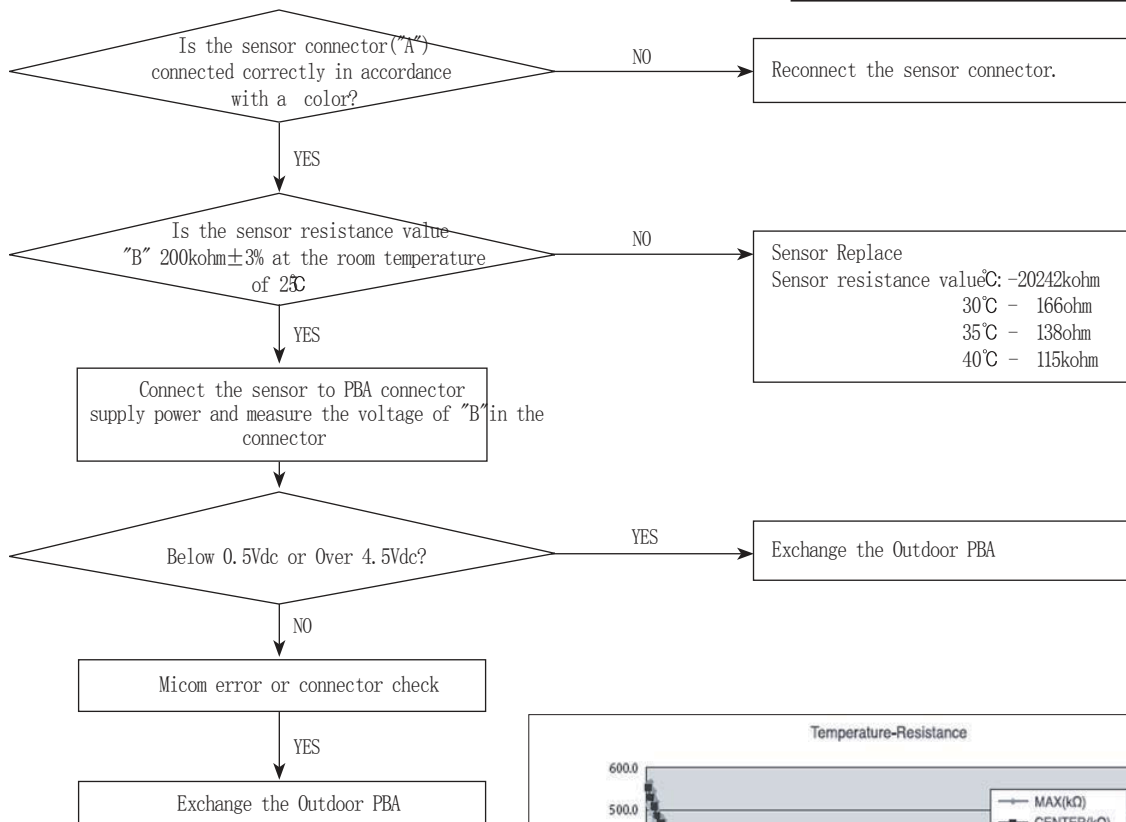

10-2-9 Outdoor Discharge over temperature error

Indoor display

3-LED DISPLAY			7-SEG DISPLAY	DESCRIPTION
LED1	LED2	LED3	E416	Outdoor Discharge over temperature error
◎	○	◎		

Outdoor display

◎	◎	●	Outdoor Discharge over temperature error
---	---	---	--

● LED ON ◎ LED BLINKING ○ LED OFF

1. Checklist :

- 1) Check the discharge temperature in the outdoor unit
- 2) Check the compressor locking or gas leak
- 3) Download the EEPROM data

2. Troubleshooting procedure

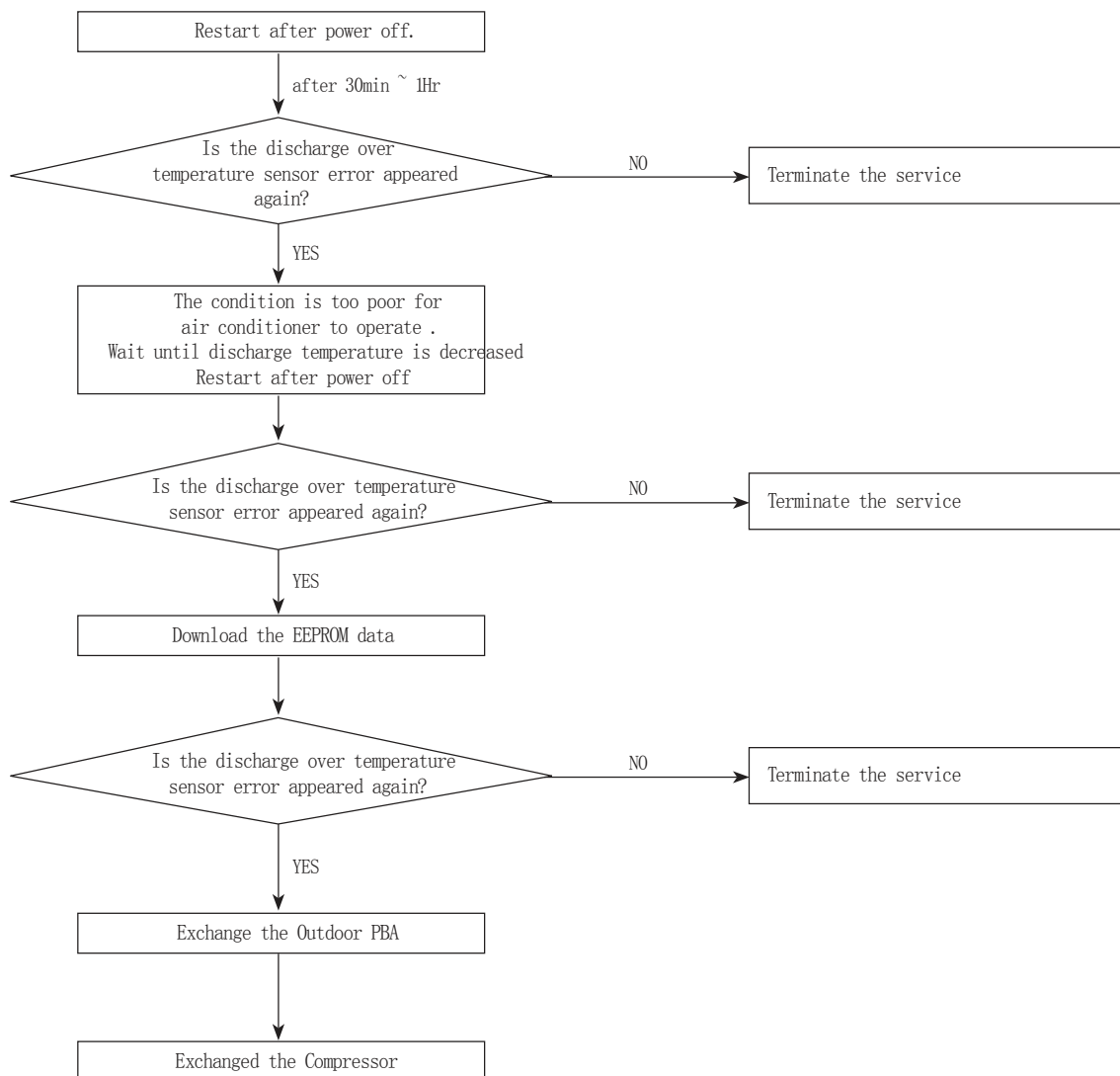

10-2-10 Outdoor Fan motor error

Indoor display

3-LED DISPLAY			7-SEG DISPLAY	DESCRIPTION
LED1	LED2	LED3	E458	Outdoor fan error
◎	○	◎		

Outdoor display

●	○	○	Outdoor fan error
---	---	---	-------------------

● LED ON ◎ LED BLINKING ○ LED OFF

1. Checklist :

- 1) Are the input power voltage and the power connection correct?
- 2) Is the motor wire connected to the outdoor PBA correctly?
- 3) Is there no assembly error or non-assembly in the terminal of motor wire connector?
- 4) Is there no obstacle at the surrounding of motor and propeller?

2. Troubleshooting procedure

MODEL	"A"
ALL	CN901

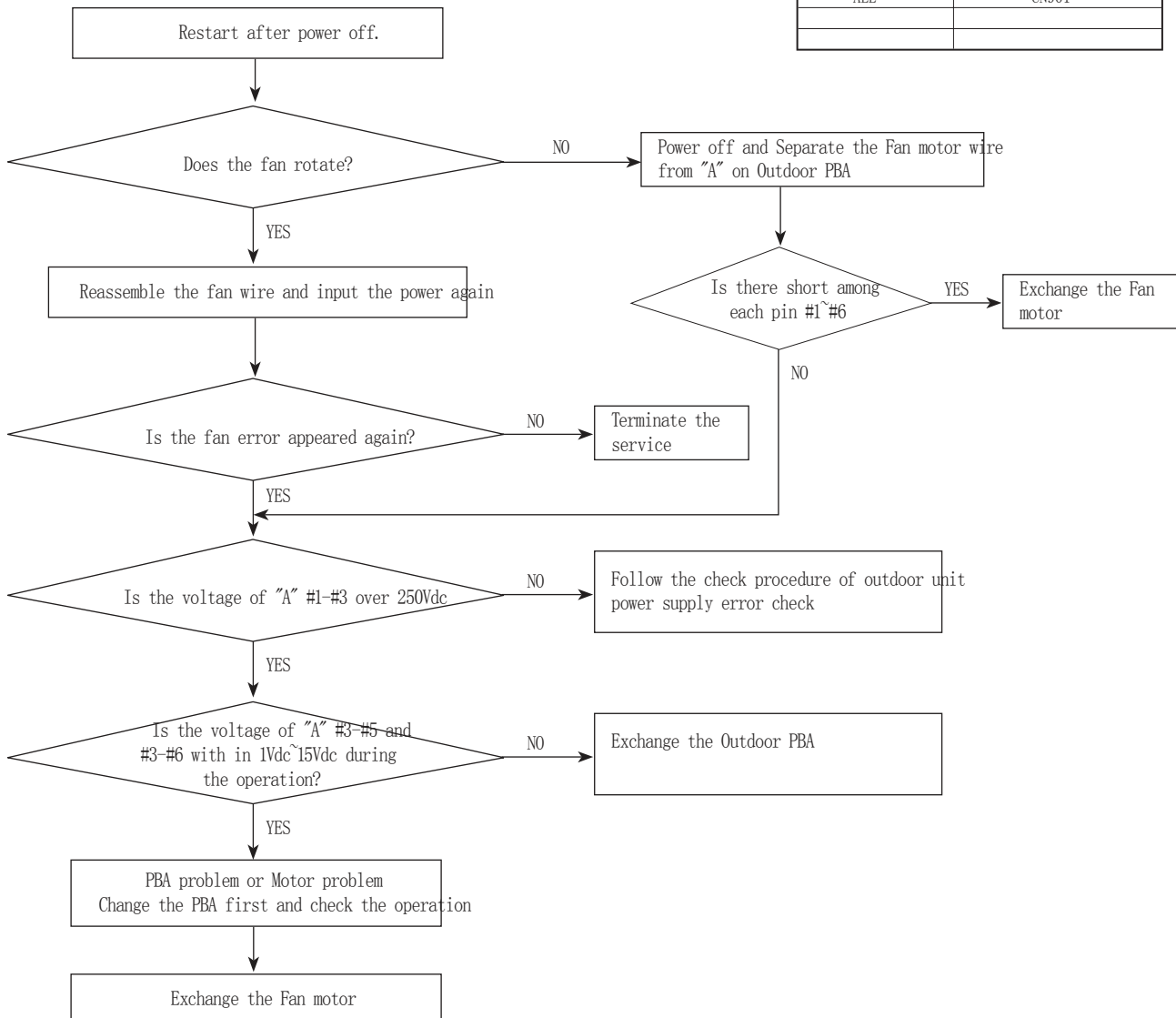

10-2-11 Compressor starting error

Indoor display

3-LED DISPLAY			7-SEG DISPLAY	DESCRIPTION
LED1	LED2	LED3	E461	Comp starting error
◎	○	◎		

Outdoor display

○	◎	○	Comp starting error
---	---	---	---------------------

● LED ON ◎ LED BLINKING ○ LED OFF

1. Checklist :

- 1) Is the connection of cable for the compressor?
- 2) Is the compressor wire is connected clockwise? U(RED)-V(BLU)-W(YEL)
- 3) Is the interphase resistance of compressor normal?

2. Troubleshooting procedure

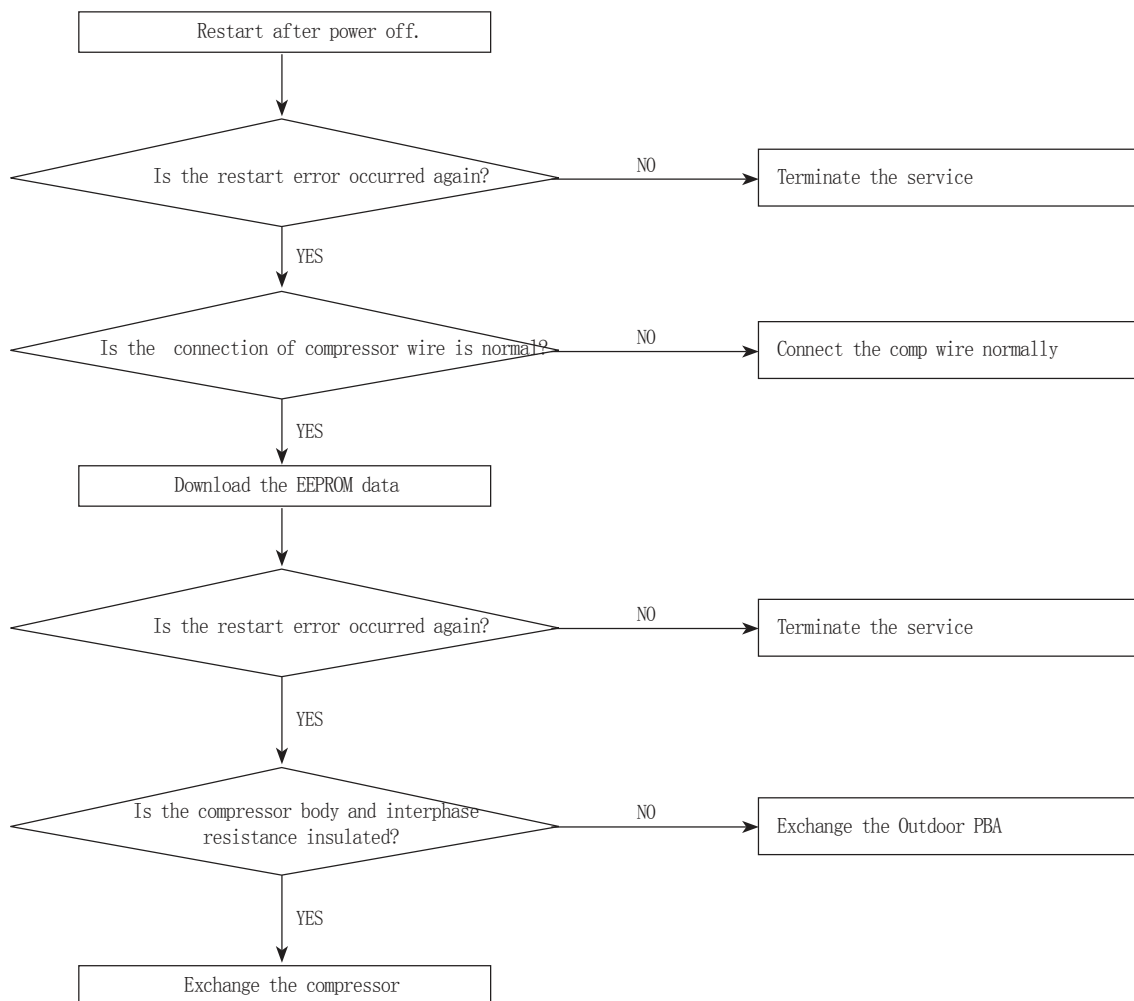

10-2-12 Compressor wire missing error/rotation error

Indoor display

3-LED DISPLAY			7-SEG DISPLAY	DESCRIPTION
LED1	LED2	LED3	E467	Compressor wire missing error/rotation error
◎	○	◎		

Outdoor display

●	○	●	Compressor wire missing error/rotation error
---	---	---	--

● LED ON ◎ LED BLINKING ○ LED OFF

1. Checklist :

- 1) Is the connection of cable for the compressor?
- 2) Is the compressor wire is connected clockwise? U(RED)-V(BLU)-W(YEL)
- 3) Is the interphase resistance of compressor normal?

2. Troubleshooting procedure

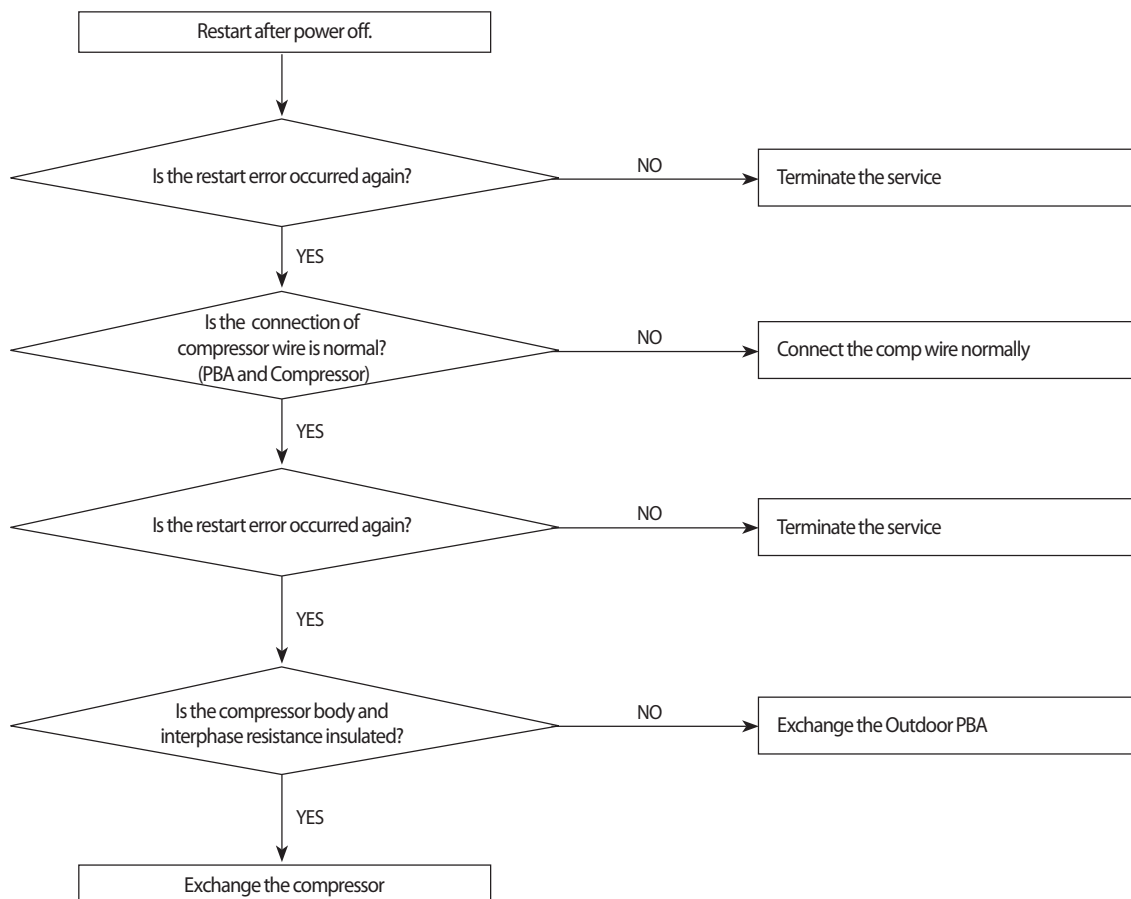

10-2-13 O.C(Over Current) error

Indoor display

3-LED DISPLAY			7-SEG DISPLAY	DESCRIPTION
LED1	LED2	LED3	E464	IPM Over Current(O.C) Error
⊙	○	⊙		

Outdoor display

○	○	⊙	IPM Over Current(O.C) Error
---	---	---	-----------------------------

● LED ON ⊙ LED BLINKING ○ LED OFF

1. Checklist :

- 1) Is the IPM Shunt resistance value correct? Check the resistor is opened
- 2) Is the condition of surrounding temperature abnormal overload?
- 3) Is there any problem as like the temperature sensor separation or measurement value error?
- 4) Is the interphase resistance of compressor normal?

2. Troubleshooting procedure

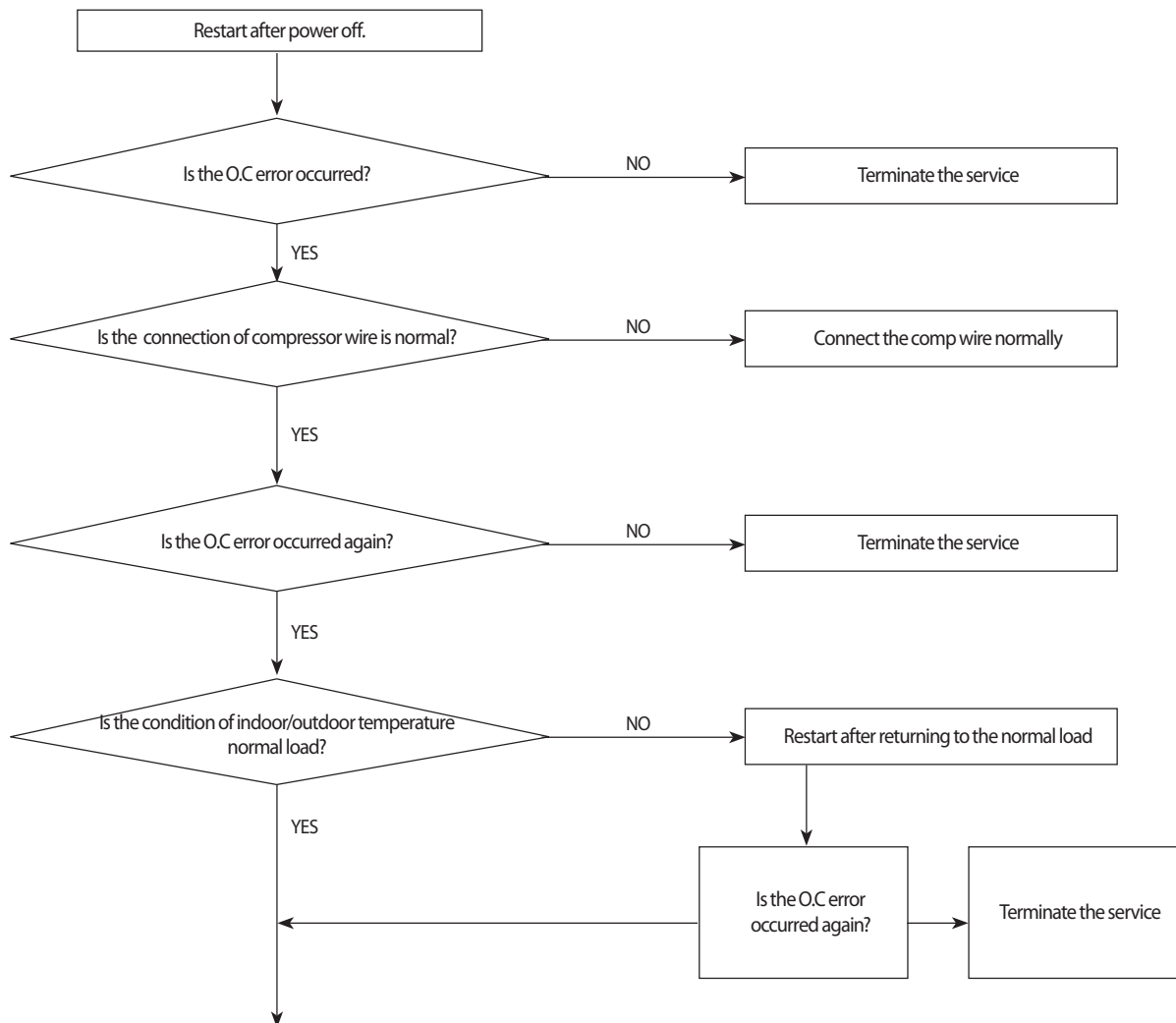

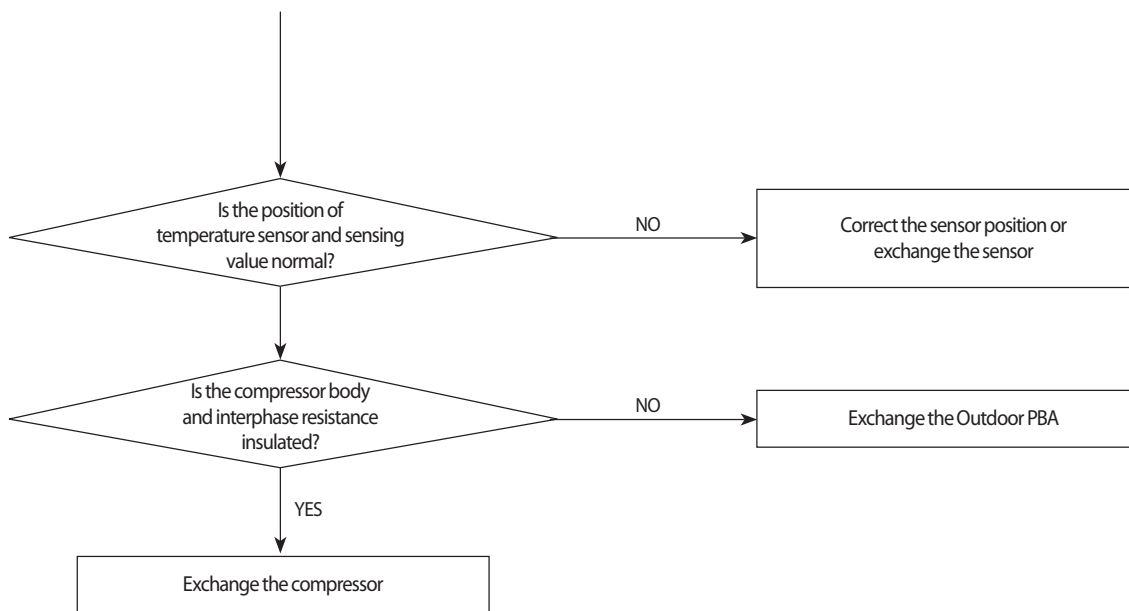

10-2-14 DC_link voltage sensor error

Indoor display

3-LED DISPLAY			7-SEG DISPLAY	DESCRIPTION
LED1	LED2	LED3	E469	DC_link voltage sensor error
⊙	○	⊙		

Outdoor display

●	⊙	○	DC_link voltage sensor error
---	---	---	------------------------------

● LED ON ⊙ LED BLINKING ○ LED OFF

1. Checklist :

- 1) Is the input voltage of outdoor terminal block is normal?
- 2) Is the reactor wire connected?
- 3) Is the DC_link capacitor("A") assembled in accordance the specification? (Outdoor PBA)
- 4) Is the DC_link resistor("B") value is normal? (Outdoor PBA)

2. Troubleshooting procedure

MODEL	"A"	"B"
DB92-02866A	CE101, CE102, CE103	R101
DB92-02867A	CE053, CE054, CE055, CE056	R062

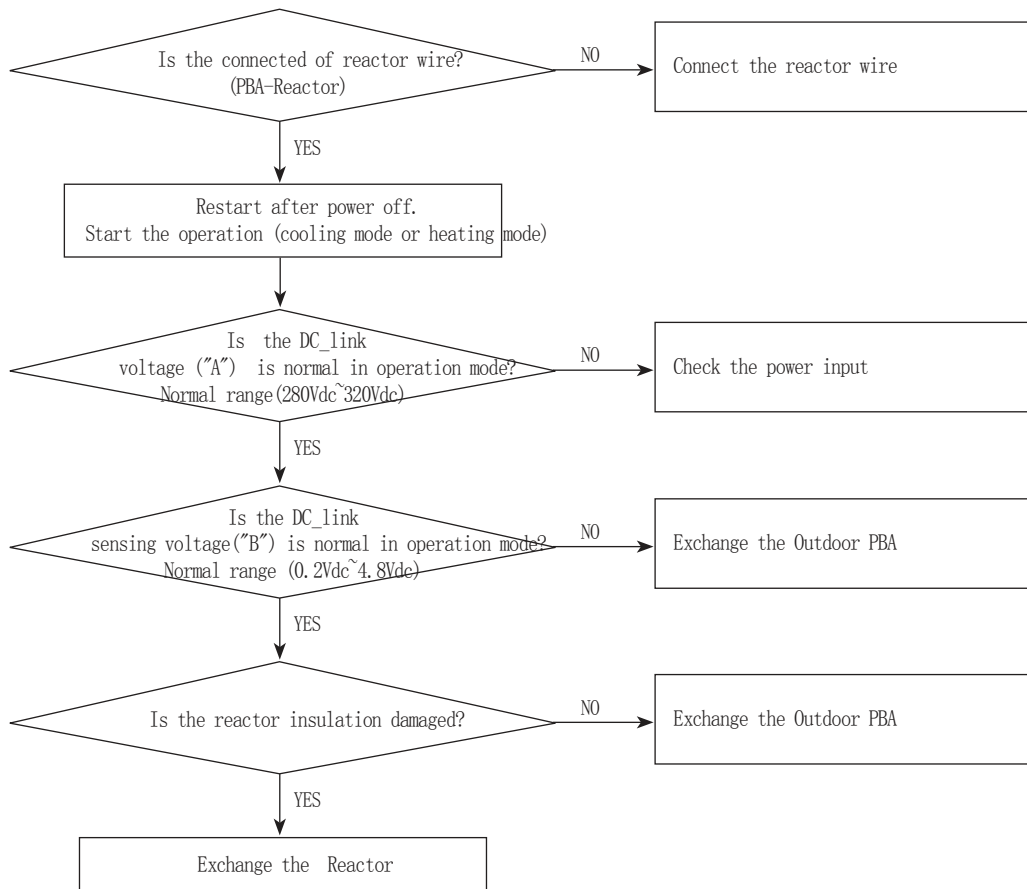

10-2-15 DC_link voltage sensor error

Indoor display

3-LED DISPLAY			7-SEG DISPLAY	DESCRIPTION
LED1	LED2	LED3	E488	AC Input Voltage Sensor Error
⊙	○	⊙		

Outdoor display

●	⊙	⊙	AC Input Voltage Sensor Error
---	---	---	-------------------------------

● LED ON ⊙ LED BLINKING ○ LED OFF

1. Checklist :

- 1) Is the input voltage of outdoor terminal block is normal?
- 2) Is the reactor wire connected?
- 3) Is the PFC resistor("A") value is normal? (Outdoor PBA)

2. Troubleshooting procedure

MODEL	"A"	"B"
DB92-02866A/2867A	R105, R106, R107, R108	R105

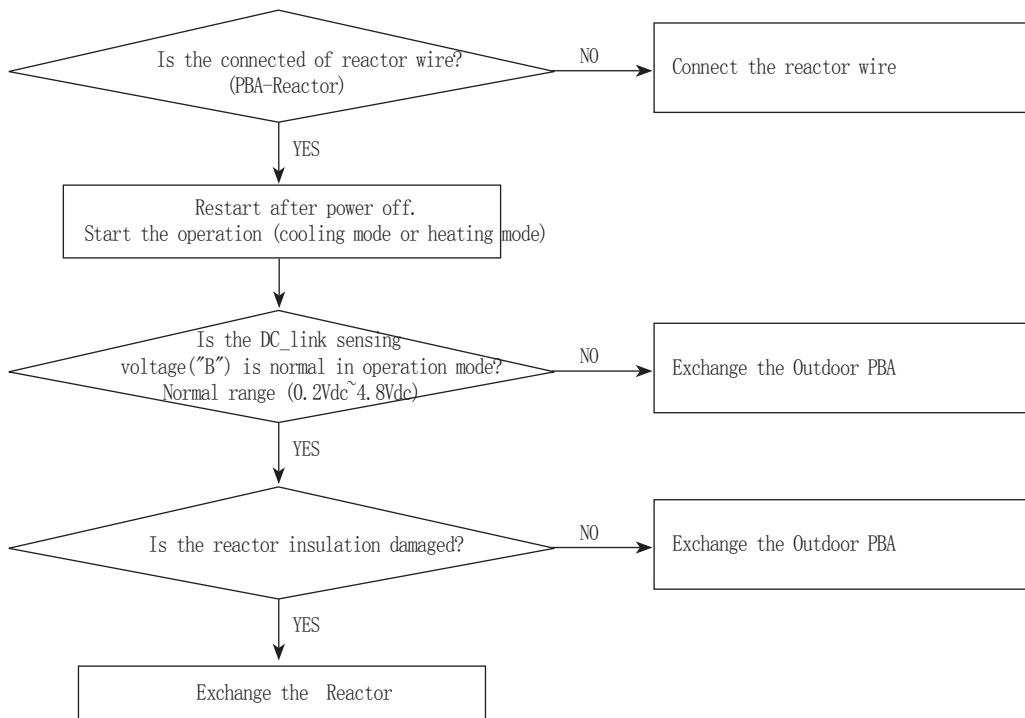

10-2-16 DC_link voltage under/over error, H/W DC-link Over voltage protection error/PFC over load

Indoor display

3-LED DISPLAY			7-SEG DISPLAY	DESCRIPTION
LED1	LED2	LED3	E466	DC-Link voltage under/over error
◎	○	◎	E483	Over Voltage Protection Error
			E484	PFC over load

Outdoor display

○	●	◎	DC-Link voltage under/over error
			PFC over load
			Over Voltage Protection Error

● LED ON ◎ LED BLINKING ○ LED OFF

1. Checklist :

- 1) Is the input voltage of outdoor terminal block is normal?
- 2) Is the input voltage is higher than 300Vac?
- 3) Is the reactor wire connected?
- 4) Is the DC_link capacitor("A") assembled in accordance the specification? (Outdoor PBA)
- 5) Is the DC_link resistor("B") value is normal? (Outdoor PBA)
- 6) Is the PFC resistor("C") value is normal? (Outdoor PBA)

MODEL	"A"	"B"
DB92-02866A	CE101, CE102, CE103	R101, R102, R103, R104
DB92-02867A	CE053, CE054, CE055, CE056	R059, R060, R061, R062

MODEL	"C"	"D"
DB92-02866A/2867A	R105, R106, R107, R108	R105

2. Troubleshooting procedure

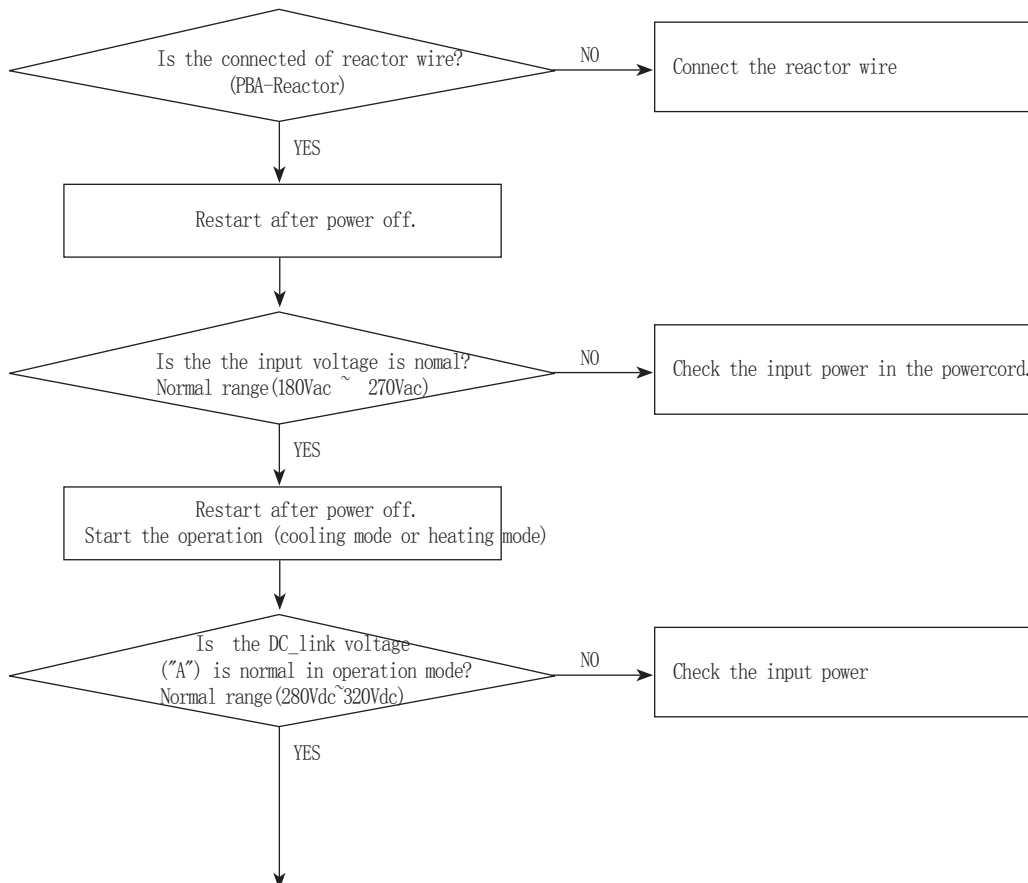

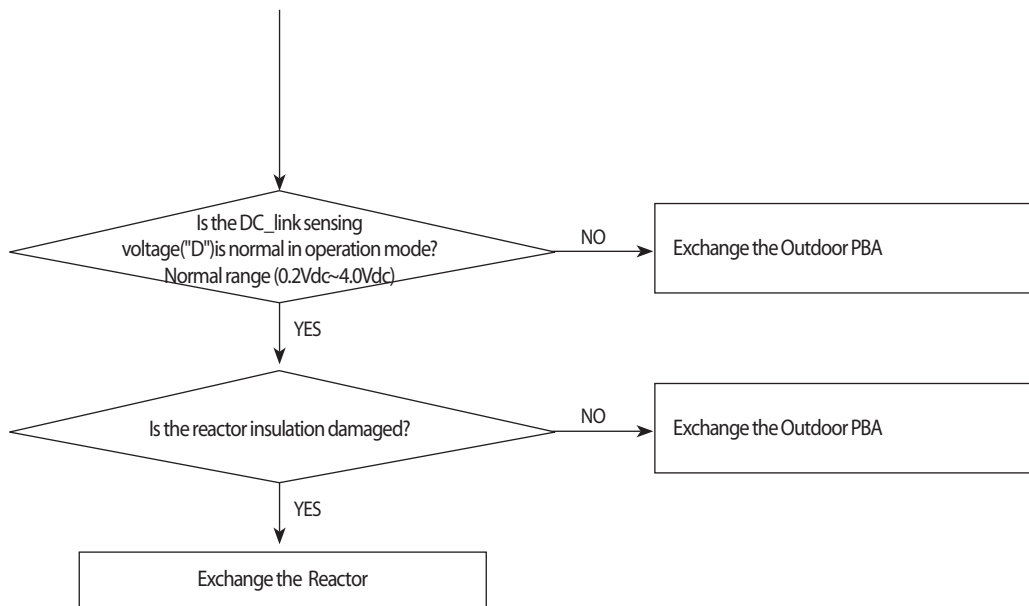

10-2-17 I_trip error, PFC over current

Indoor display

3-LED DISPLAY			7-SEG DISPLAY	DESCRIPTION
LED1	LED2	LED3	E462	AC Input I_Limit Trip Error
⊙	○	⊙		

Outdoor display

●	⊙	●	AC Input I_Limit Trip Error
---	---	---	-----------------------------

● LED ON ⊙ LED BLINKING ○ LED OFF

1. Checklist :

- 1) Is the PFC Shunt("A") resistance value correct? Check the resistor is opened
- 2) Is the condition of surrounding temperature abnormal overload?
- 3) Is there any problem as like the temperature sensor separation or measurement value error?
- 4) Is the interphase resistance of compressor normal?

2. Troubleshooting procedure

MODEL	"A"
DB92-02866A	R410, R411, R412
DB92-02867A	R408, R409, R410

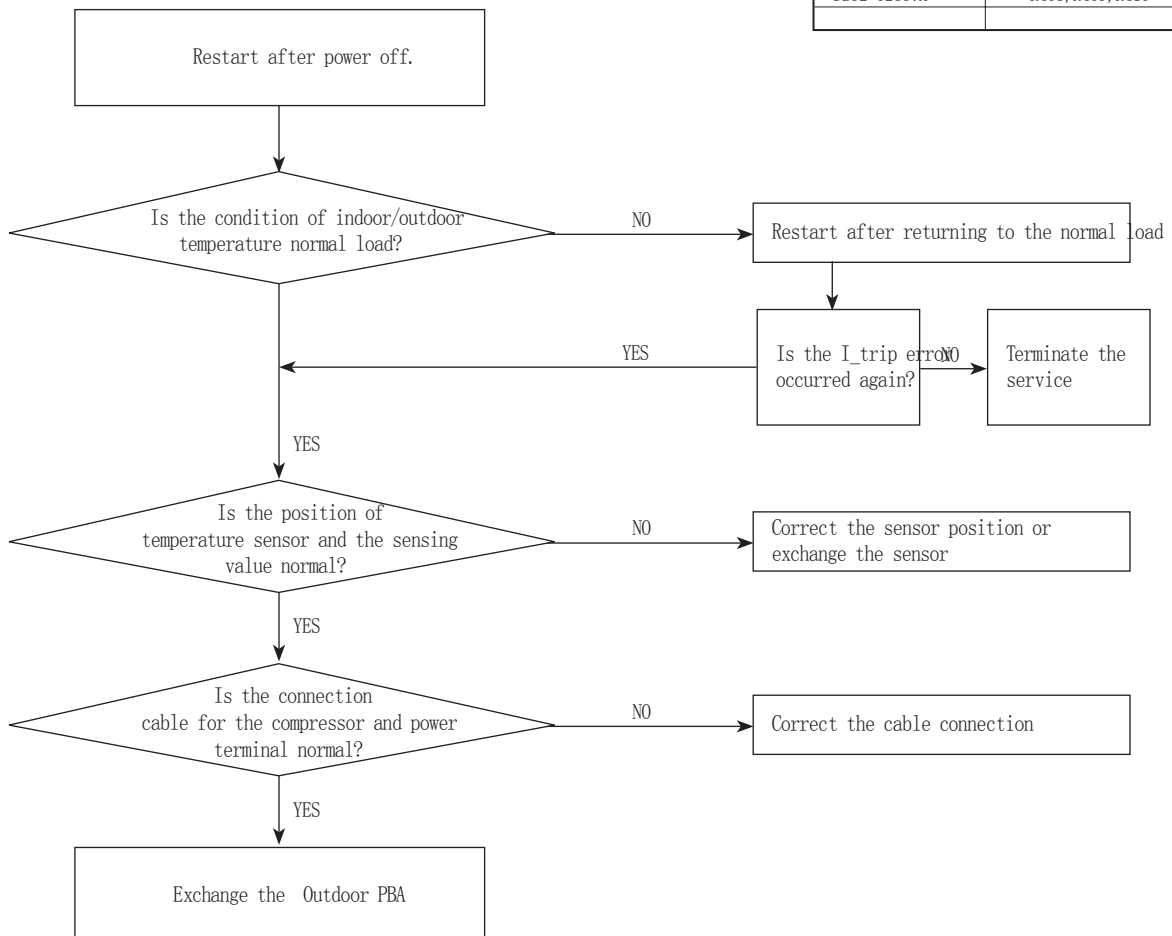

10-2-18 Current sensor error/Input current sensor error

Indoor display

3-LED DISPLAY			7-SEG DISPLAY	DESCRIPTION
LED1	LED2	LED3		
◎	○	◎	E462	AC Input I_Limit Trip Error

Outdoor display

◎	◎	●	Current sensor error
			Input current sensor error

● LED ON ◎ LED BLINKING ○ LED OFF

1. Checklist :

- 1) Is the PFC Shunt("A") resistance value correct? Check the resistor is opened
- 2) Is the IPM Shunt("B") resistance value correct? Check the resistor is opened
- 3) Is there no short or open around "C"?

2. Troubleshooting procedure

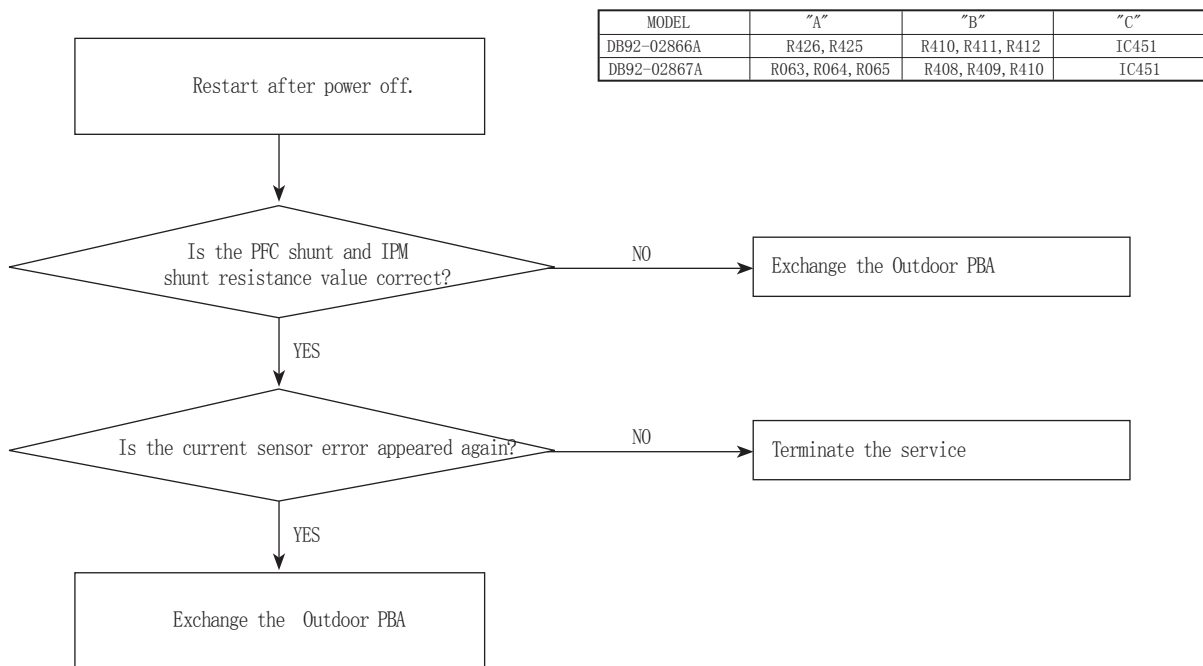

10-2-19 Heatsink sensor error/Heatsink over heat

Indoor display

3-LED DISPLAY			7-SEG DISPLAY	DESCRIPTION
LED1	LED2	LED3		
⊙	○	⊙	E474	Heatsink sensor error
			E500	Heatsink Over Temperature Error

Outdoor display

⊙	⊙	●	Heatsink sensor error
⊙	●	○	Heatsink Over Temperature Error

● LED ON ⊙ LED BLINKING ○ LED OFF

1. Checklist :

- 1) Are there screws assembly in PBA-heatsink?
- 2) Is the gap PBA-heatsink
- 3) Is the fan operation normal?
- 4) Is the cover assembly in control-box normal?

2. Troubleshooting procedure

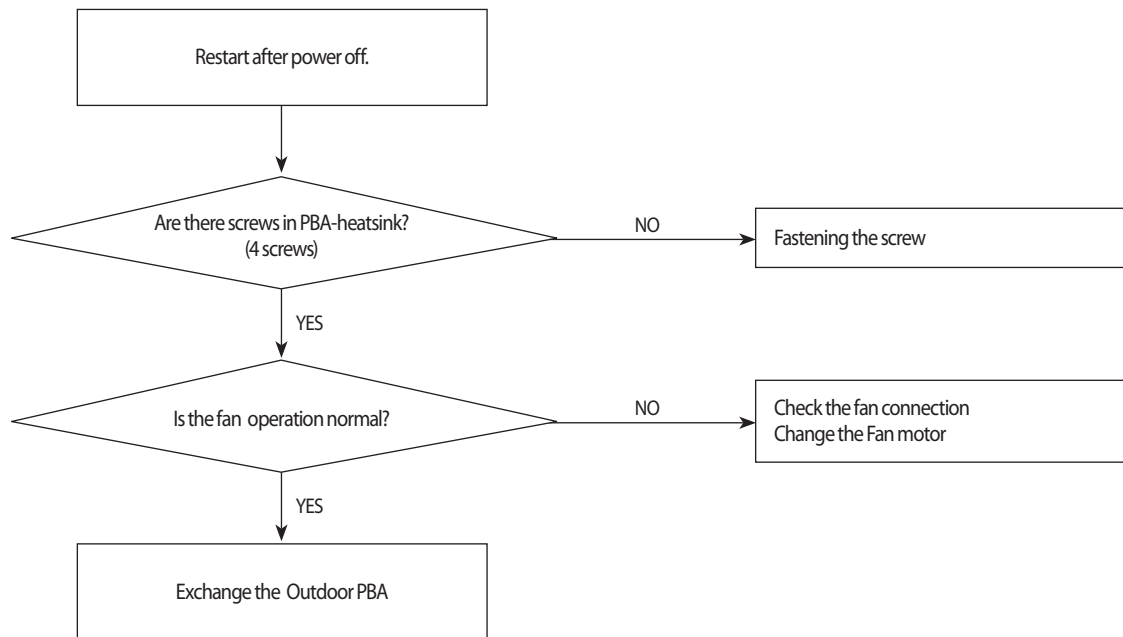

10-2-20 Comp Vlimit error

Indoor display

3-LED DISPLAY			7-SEG DISPLAY	DESCRIPTION
LED1	LED2	LED3		
◎	○	◎	E465	Comp V_limit/I_limit Error

Outdoor display

◎	●	○	Comp V_limit/I_limit Error
---	---	---	----------------------------

● LED ON ◎ LED BLINKING ○ LED OFF

1. Checklist :

- 1) Is the IPM Shunt("A") resistance value correct? Check the resistor is opened
- 2) Is the condition of surrounding temperature abnormal overload?
- 3) Is there any problem as like the temperature sensor separation or measurement value error?
- 4) Is the interphase resistance of compressor normal?

2. Troubleshooting procedure

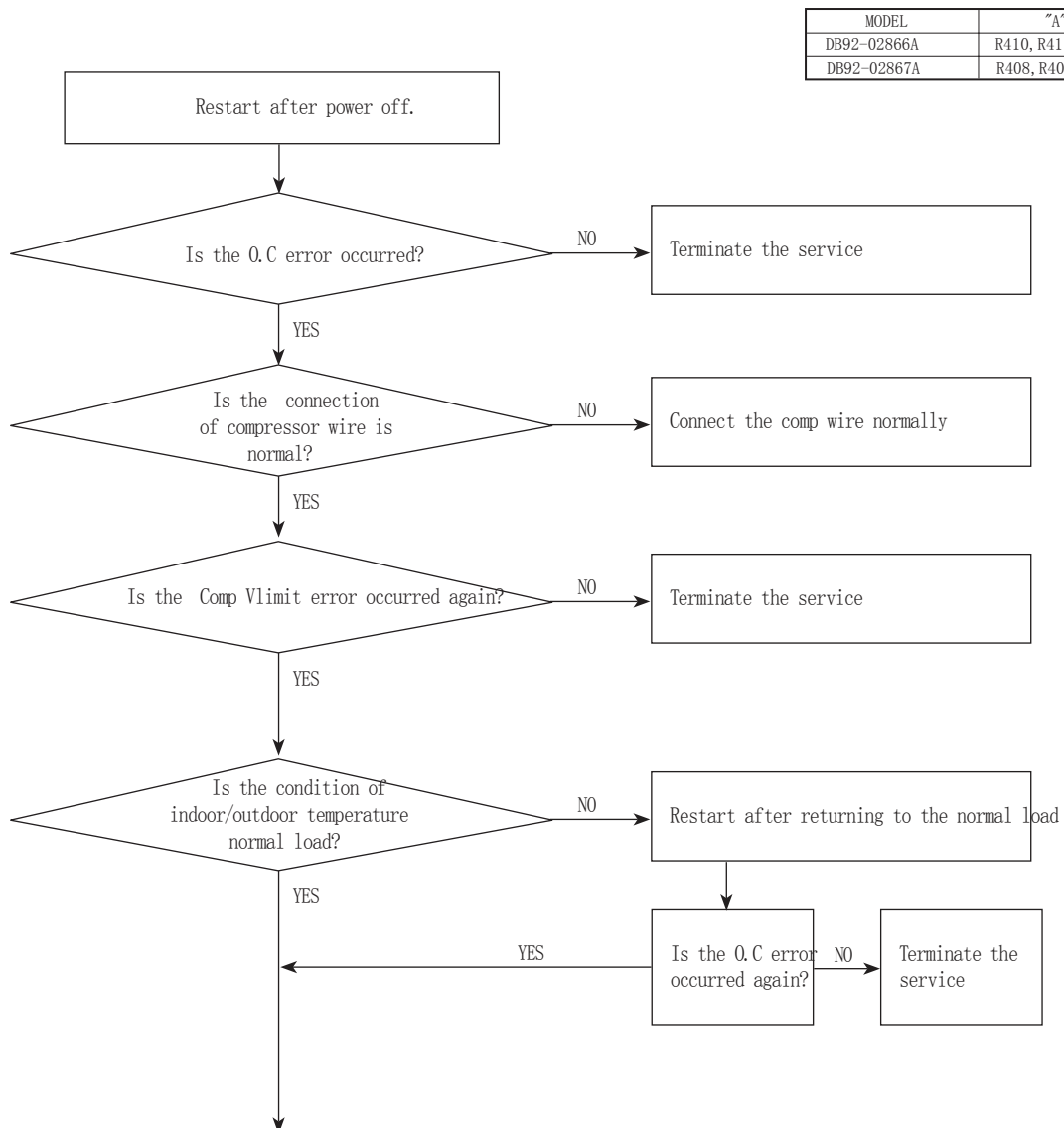

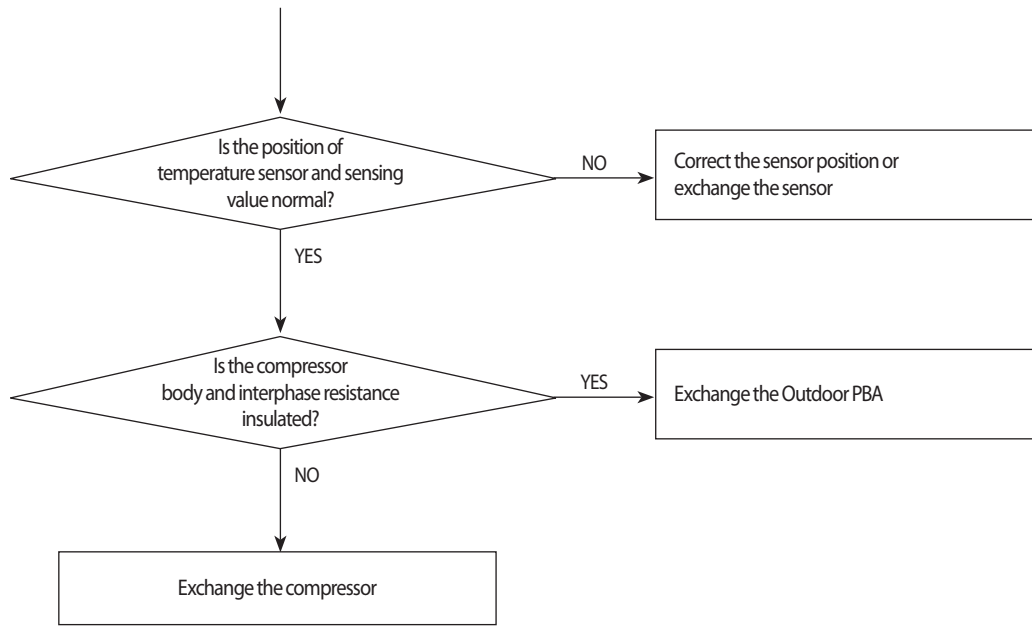

10-2-21 EEPROM error/OTP error

Indoor display

3-LED DISPLAY			7-SEG DISPLAY	DESCRIPTION
LED1	LED2	LED3		
◎	○	◎	E470	EEPROM Data Error (no data)
			E471	OTP errorEEPROM Data Error (Main Micom↔Inv Micom)

Outdoor display

○	●	○	EEPROM Data Error (no data)
●	○	◎	OTP errorEEPROM Data Error (Main Micom↔Inv Micom)

● LED ON ◎ LED BLINKING ○ LED OFF

1. Checklist :

- 1) Is there a short around micom?
- 2) Is there a short around "A"?
- 3) Did you download or insert EEPROM IC, after changing outdoor PBA?

2. Troubleshooting procedure

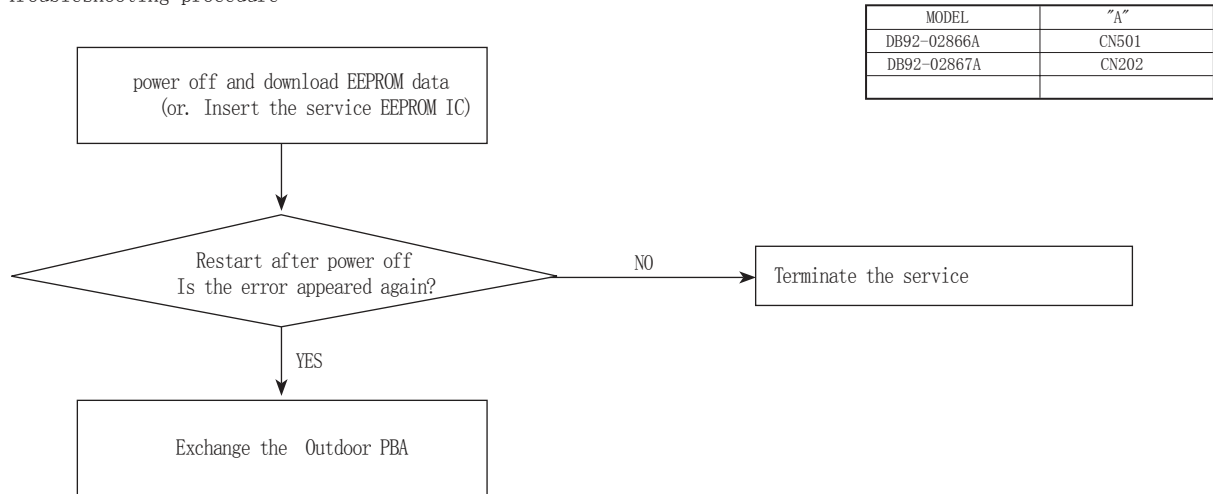

10-2-22 Operation condition secession error

Indoor display

3-LED DISPLAY			7-SEG DISPLAY	DESCRIPTION
LED1	LED2	LED3		
◎	○	◎	E440	Prohibit Operation Condition Error (Heating)
			E441	Prohibit Operation Condition Error (Cooling)

Outdoor display

●	◎	○	Operation condition secession
---	---	---	-------------------------------

● LED ON ◎ LED BLINKING ○ LED OFF

1. Checklist :

- 1) Check the temperature around the outdoor unit.

2. Troubleshooting procedure

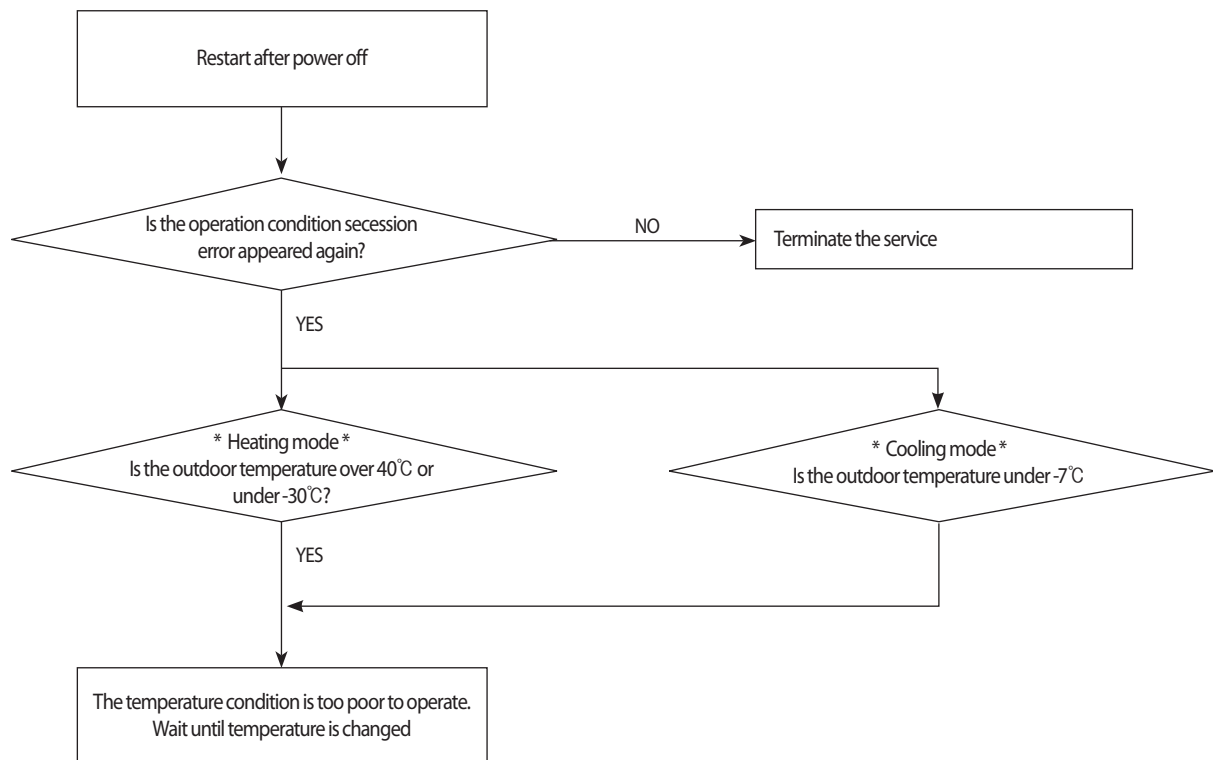

10-2-23 Gas leak error

Indoor display

3-LED DISPLAY			7-SEG DISPLAY	DESCRIPTION
LED1	LED2	LED3		
◎	○	◎	E554	GAS Leak error

Outdoor display

●	●	○	GAS Leak error
---	---	---	----------------

● LED ON ◎ LED BLINKING ○ LED OFF

1. Checklist :

- 1) Is the position of indoor Eva_in sensor normal?
- 2) Check the pipe crack
- 3) Check the EEV valve connection("A") in Outdoor unit
- 4) Check the refrigerant was charged

2. Troubleshooting procedure

MODEL	"A"
DB92-02866A	CN701
DB92-02867A	CN701

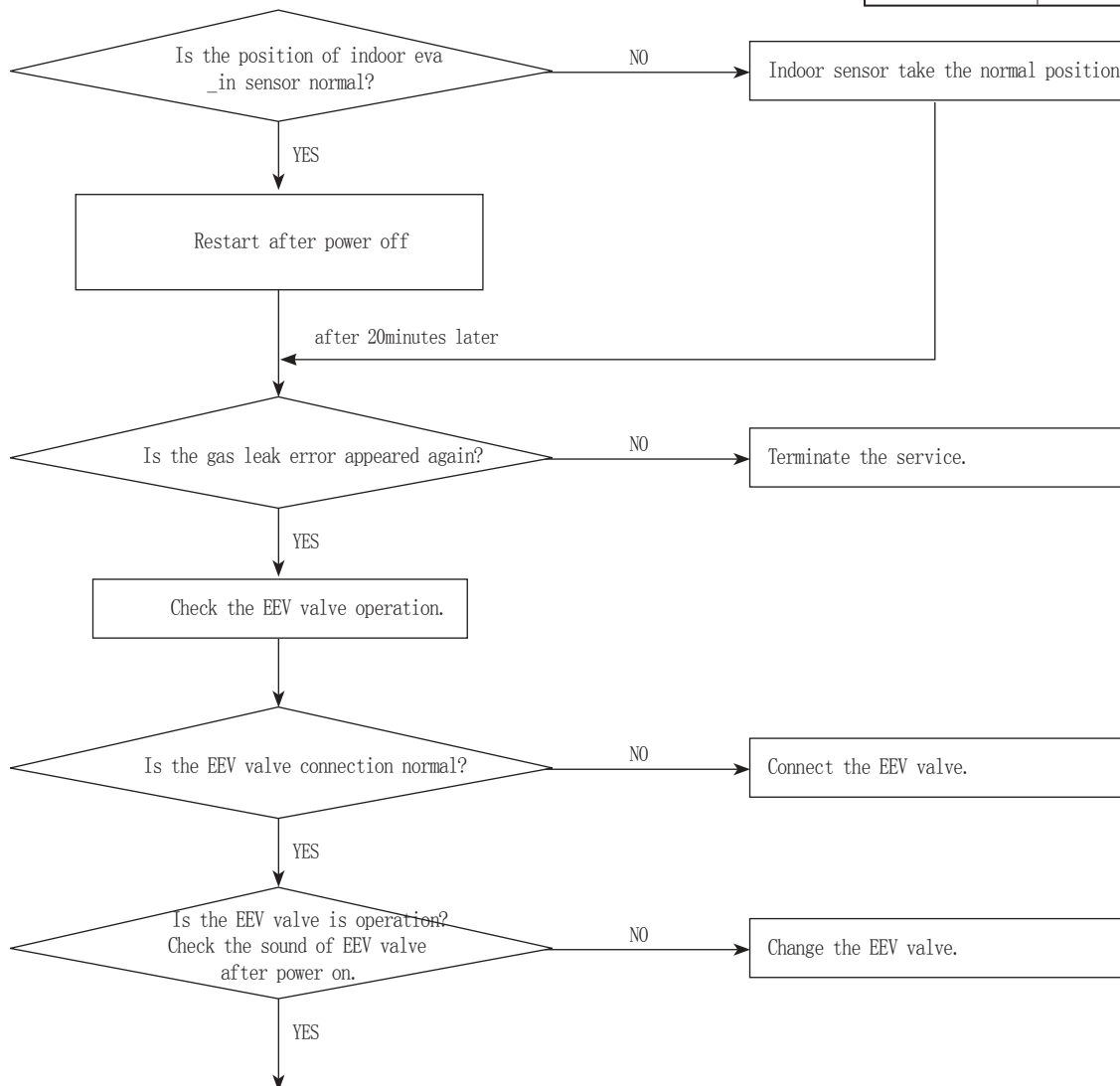

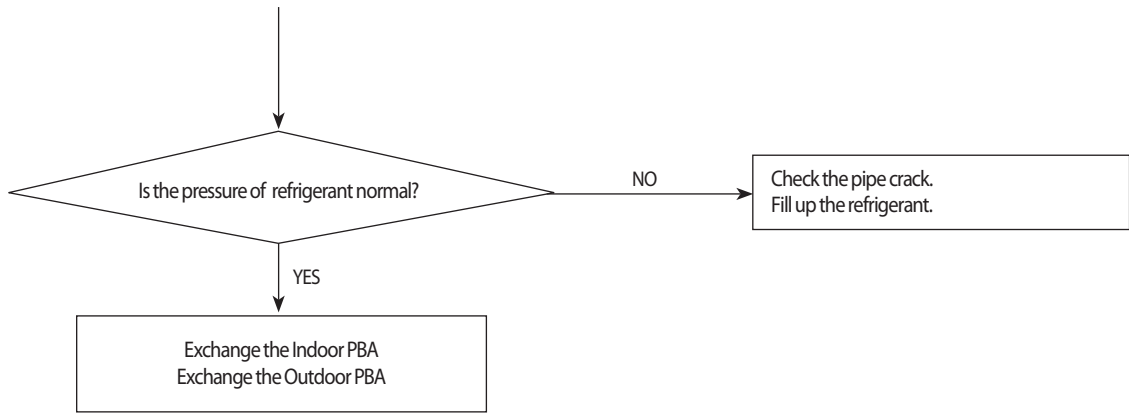

102-24 No power outdoor (Initial Diagnosis) (Not displayed)

1. Checklist :

- 1) Is input power normal?
- 2) Is AC power linked correctly? (L, N, E)
- 3) Is mis-wiring between communication wire and Power wire?
- 4) Is mis-wiring between Main PBA and SMPS PBA wire?
- 5) Is input voltage of SMPS AC in Main PBA (CN150) normal?
- 6) Is the voltage of SMPS DC in Main PBA (CN151, CN152) normal?

2. Troubleshooting procedure

MODEL
ALL

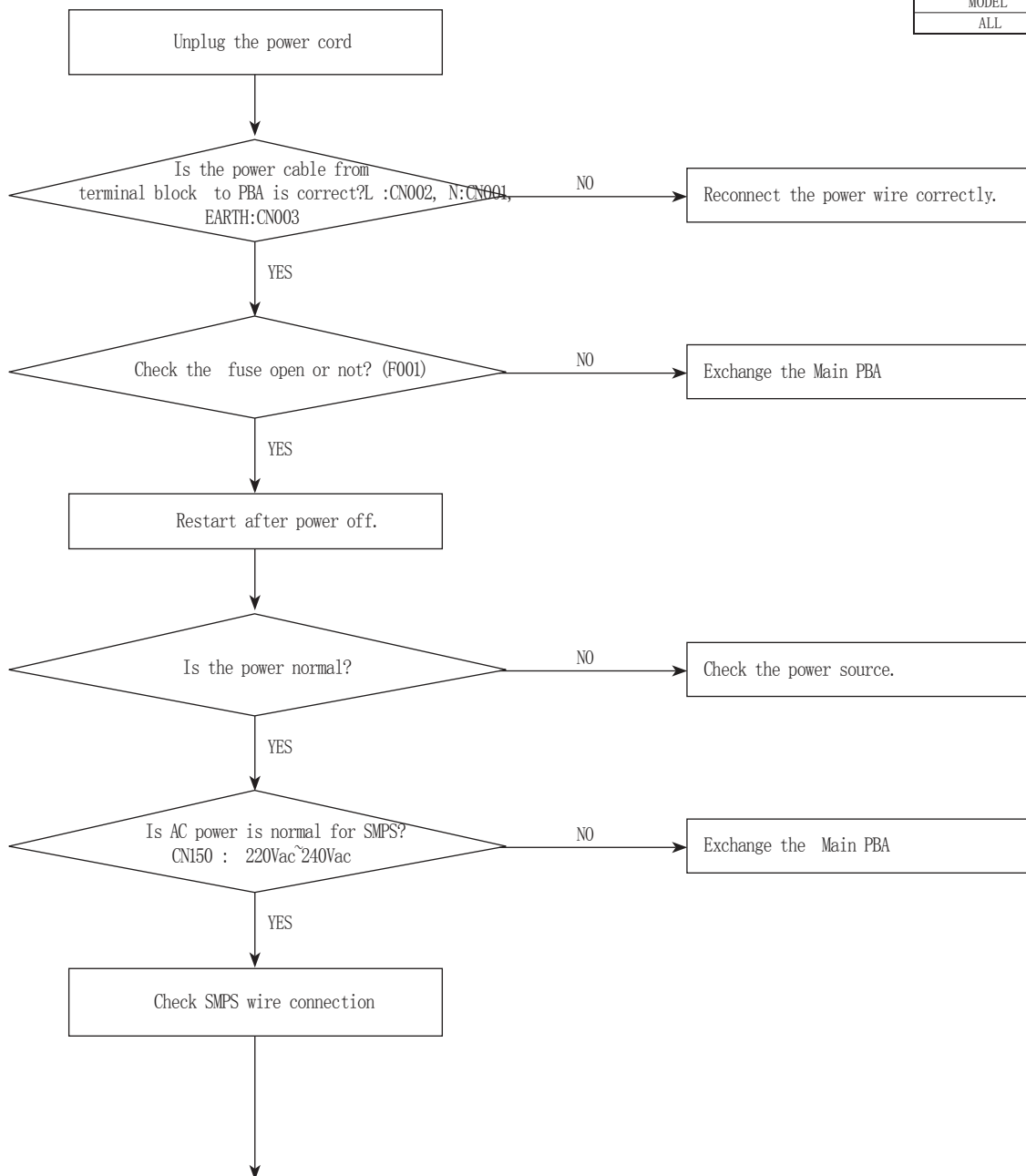

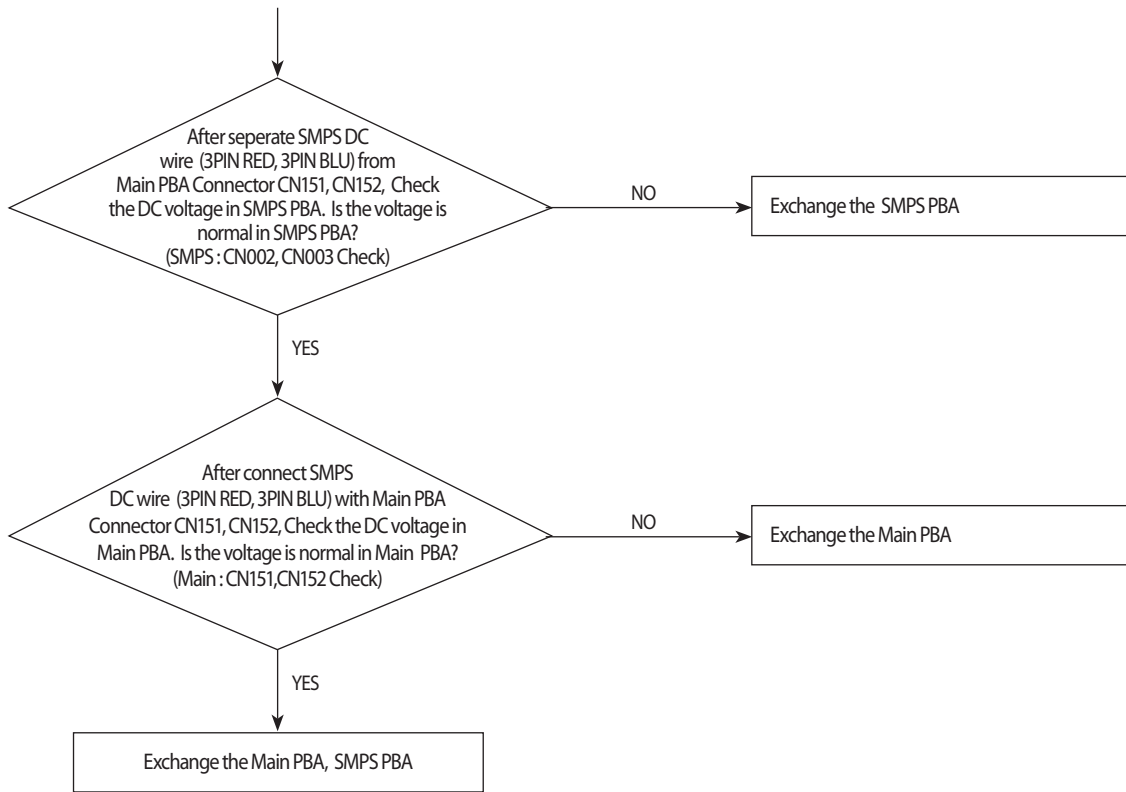

10-2-25 No power outdoor (Initial Diagnosis) (Not displayed)

1. Checklist :

- 1) Is input power normal?
- 2) Is AC power linked correctly? (L, N, E)
- 3) Is mis-wiring between communication wire and Power wire?
- 4) Is input voltage of SMPS DC-link capacitor("A") normal?
- 5) Is the voltage of SMPS DC normal?

2. Troubleshooting procedure

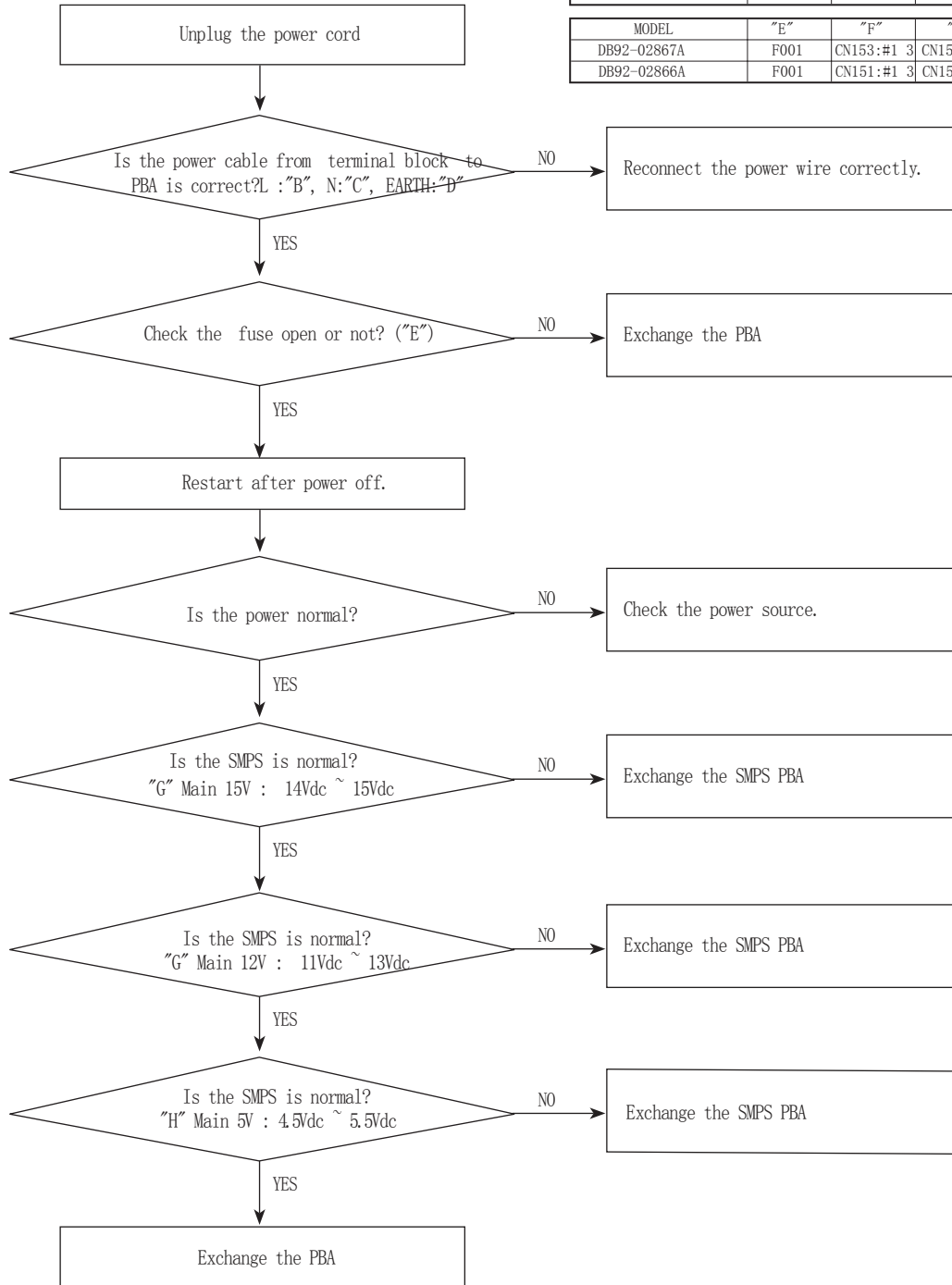

MODEL	"A"	"B"	"C"	"D"
DB92-02867A	CE101	CN002	CN001	CN003
DB92-02866A	CE101	CN002	CN001	CN003

MODEL	"E"	"F"	"G"	"H"
DB92-02867A	F001	CN153:#1 3	CN152#1 2	CN152#2 3
DB92-02866A	F001	CN151:#1 3	CN152#1 2	CN152#2 3

10-2-26 AC zero cross signal error

Indoor display

3-LED DISPLAY			7-SEG DISPLAY	DESCRIPTION
LED1	LED2	LED3		
◎	○	◎	E472	AC zero cross signal error

Outdoor display

●	●	◎	AC zero cross signal error
---	---	---	----------------------------

● LED ON ◎ LED BLINKING ○ LED OFF

1. Checklist :

- 1) Check the power condition at customer's house (Is there any power noise?)
- 2) Have been there power failure?

2. Troubleshooting procedure

MODEL	Error display
DB92-02866A/2867A	0

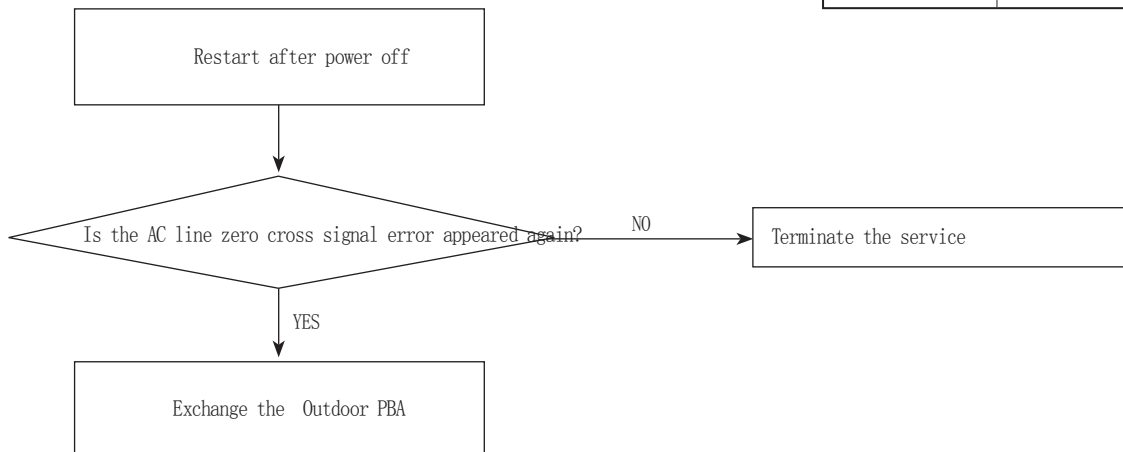

10-2-27 AC zero cross signal error

Indoor display

3-LED DISPLAY			7-SEG DISPLAY	DESCRIPTION
LED1	LED2	LED3		
◎	○	◎	E556	Capacity miss match error

Outdoor display

◎	○	○	Capacity miss match error	
---	---	---	---------------------------	--

● LED ON ◎ LED BLINKING ○ LED OFF

1. Checklist :

- 1) Check the Btu between indoor and outdoor unit
- 2) Check the indoor unit option and outdoor unit EEPROM data

2. Troubleshooting procedure

MODEL	Error display
DB92-02866A/2867A	0

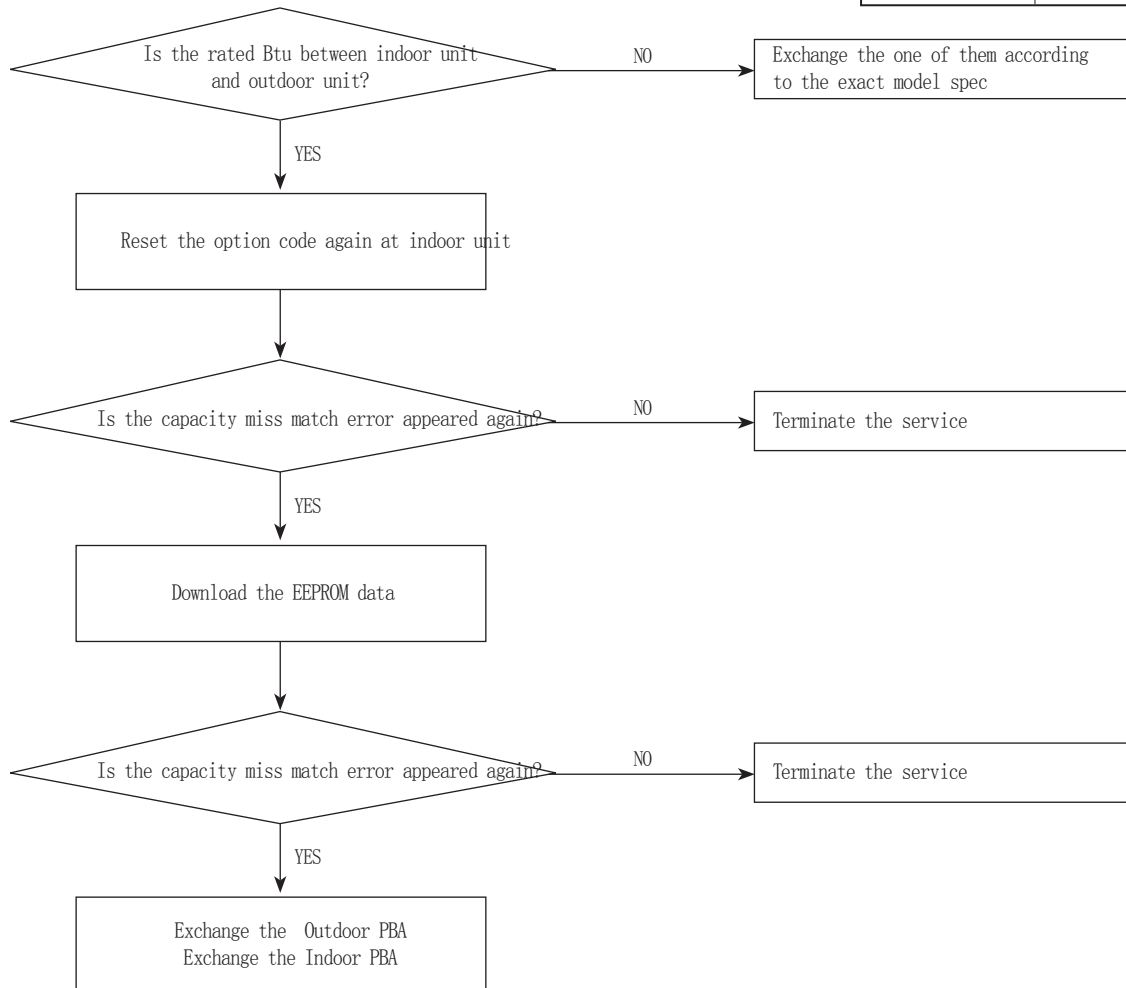

10-2-28 When the remote control is not receiving

1. Checklist :

- 1) Check if the connector was normally assembled.
- 2) Check the battery in remote control
- 3) All the lights out and check again : Change electronic typed to a fluorescent light
- 4) Put the set in operation and check the voltage of display PBA
- 5) Replace the display PBA

10-2-29 EEV or Valve Close error-Self diagnosis

Indoor display

3-LED DISPLAY			7-SEG DISPLAY	DESCRIPTION
LED1	LED2	LED3		
◎	○	◎	E422	EEV or Valve Close error-Self diagnosis

Outdoor display

●	●	○	EEV or Valve Close error-Self diagnosis
---	---	---	---

● LED ON ◎ LED BLINKING ○ LED OFF

1. Checklist :

- 1) Is the position of indoor Eva_in sensor normal?
- 2) Check the pipe crack
- 3) Check the EEV valve connection("A") in Outdoor unit
- 4) Check the refrigerant was charged

MODEL	"A"
DB92-02866A/2867A	CN701

2. Troubleshooting procedure

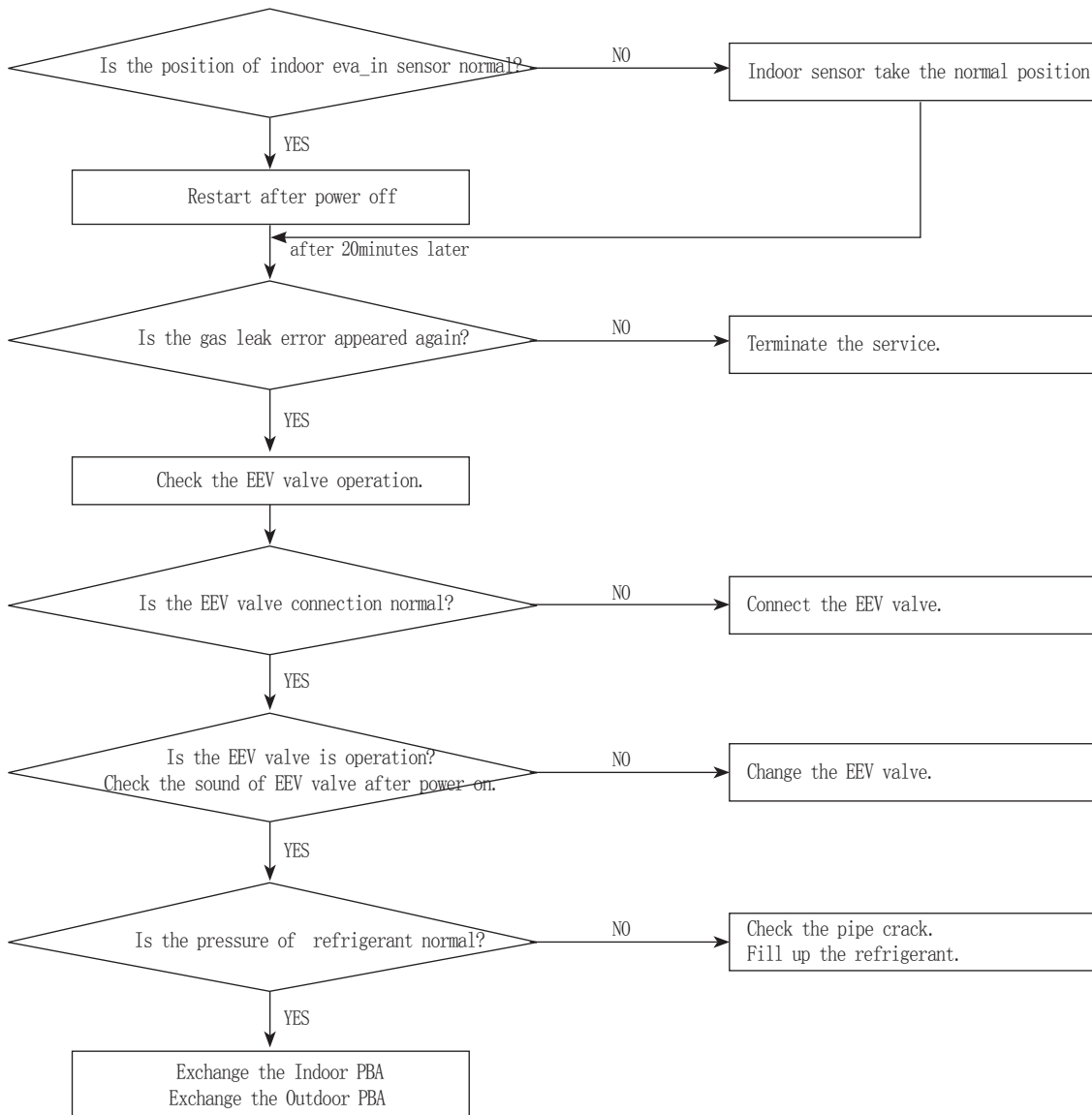

10-2-30 10-3-18 Smart Install error

1. Checklist :

- 1) Check the leakage region.(Use leakage detection liquid or soapy water)
- 2) When leakage region is found from service valve and piping connection flare nut part : After the related measures to check the refrigerant supplements and operation.
- 3) If the leakage region is pipe welding part : Weld leakage region after refrigerant gas release.(Brass parts should only apply)
- 4) If the leakage region is surface area (Heat exchanger or pipe welding region is not) : Replace parts.
- 5) Check the PBA Relay
 - Display of indoor unit : Ensure that the operating pilot lamp has been lighted.
 - Ensure that the Relay input voltage of indoor unit PBA is normally.(If the PBA is defective, replace)

2. Troubleshooting procedure

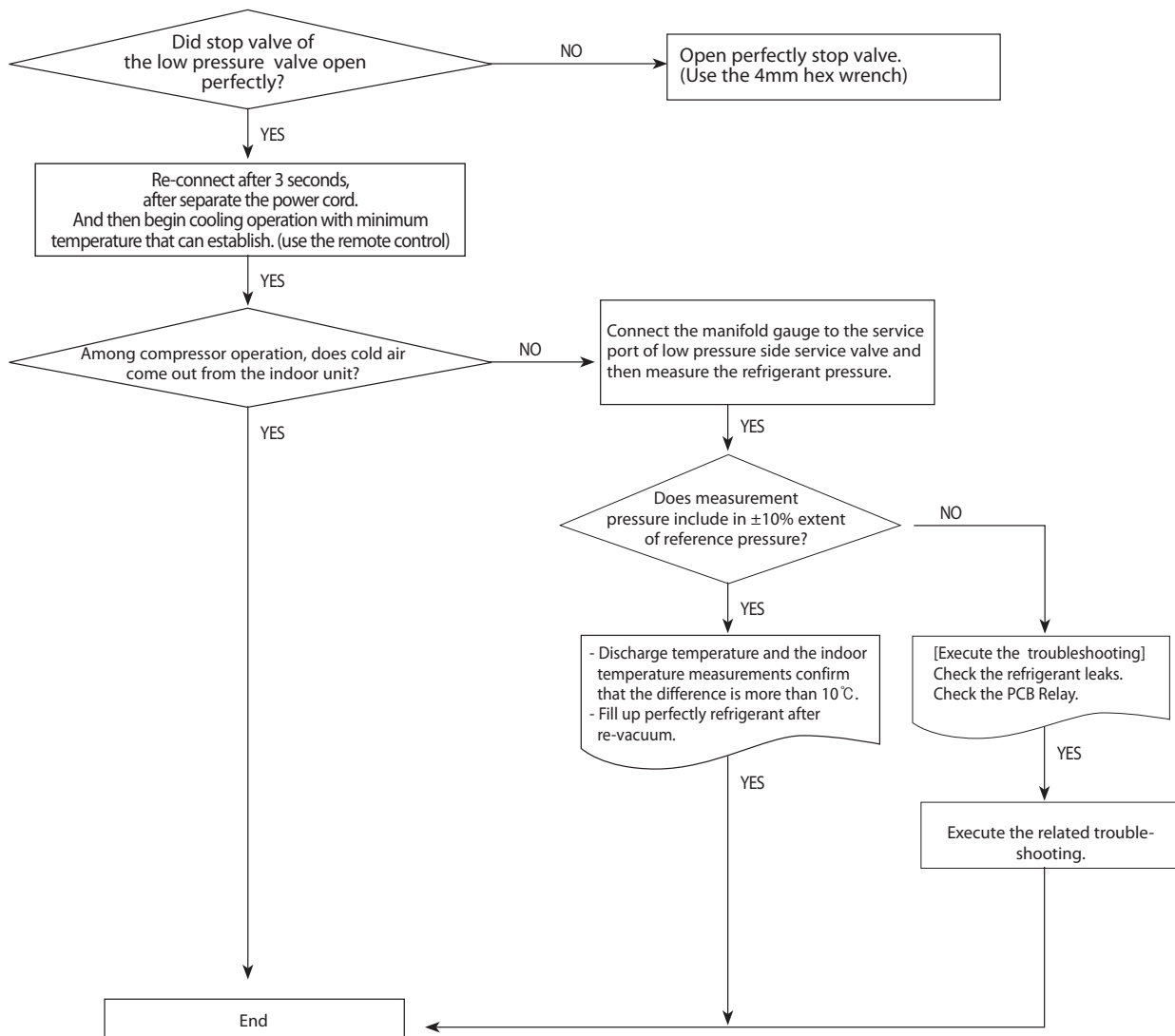

10-3 PCB Inspection Method

10-3-1 Pre-inspection Notices

1. Check if you pulled out the AC power plug when you eliminate the PCB or front panel.
2. Don't hold the PCB side not impose excessive force on it to eliminate the PCB.
3. Don't pull the lead wire but hold the whole housing to connect or disconnect a connector to the PCB.
4. In case of outdoor PCB disassembly, check first the complete discharge of condenser after 1 minute power off.

10-3-2 Inspection procedure

1. Check connector connection and peeling of PCB or bronze coating pattern when you think the PCB is broken.
2. The PCB is composed of 3 parts.
 - . Indoor Main part : MICOM and surrounding circuit, relay, fan motor sensing and driving circuit, temperature sensing circuit power circuit of SMPS, buzzer circuit. Communication circuit.
 - . Display part : LED lamp, Switch, Remote-control module.
 - . Outdoor Main part : MICOM and surround circuit, fan motor sensing and driving circuit, compressor driving circuit power circuit of SMPS, PFC control circuit, 4way circuit, communication circuit, OPTION.(EEV control circuit, temperature sensing circuit)

10-3-3 Indoor detailed inspection procedure

No	procedure	Inspection Method	Cause
1	Plug out and pull the PCB out of the control box Check the PCB fuse.	1) Is 1st fuse disconnected? 2) Is 2nd fuse disconnected?	. Over current. . Indoor Fan motor short. . AC part and pattern short of Indoor PBA.
2	Supply power If the operating lamp twinkles at this time , the above 1)~3) have no relation.	Check the power voltage	
		1) Is the BD71 input voltage 200Vac ~240Vac?	. Power cord is fault, Fuse open, Wrong Power cable Wiring, AC part is faulty.
		2) Is the voltage between both terminal of C111(+)-(-) 12Vdc?	. Switching Trans of Power circuit is faulty.
		3) Is the voltage between both terminal of C118(+)-(-) 5Vdc?	. Power circuit is faulty, Load short.
3	Press the ON/OFF button. 1. Fan speed(high) 2. Continuous Operation	1) Is the voltage over DC 270V being imposed on terminal #1~#3 of fanmotor connector(CN72)?	. Fan motor of the indoor is faulty.
		2) The fan motor of the indoor unit doesn't run.	. Fan motor connector(CN72) is faulty.
		3) The power voltage between terminal #1-#3 of the connector(CN72) is 0V.	. PBA is faulty.

■ New Function [Indoor Terminal Block Safety Device]

1. Thermal Fuse is installed in Terminal Block as below.

(Thermal Fuse is used to prevent PL caused by a defective connection of indoor and outdoor units)

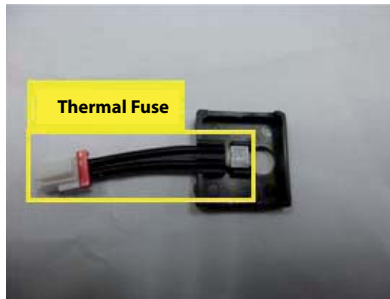

Terminal Block Internals



Connection of terminal block and Main PBA

2. Thermal Fuse is opened when internal temperature of Terminal Block goes to a certain point due to Tracking caused by a defective connection of indoor and outdoor units.

- When Thermal Fuse is opened, Main PBA (DC12V) is turned off and the indoor unit does not operate.
(There is no problem with Main PBA in this case)
- In the above case, the change of all-in-one Terminal Block will make Main PBA operate again.

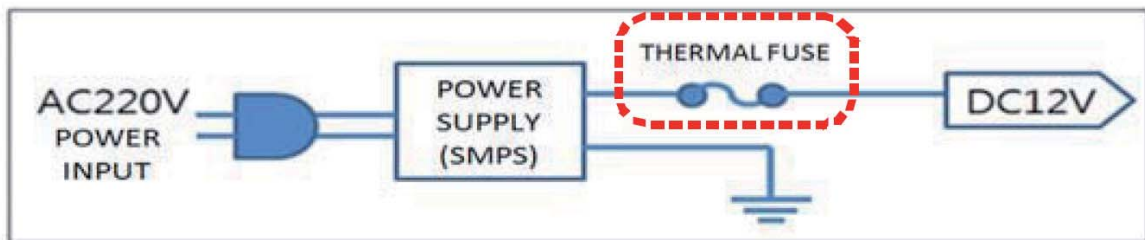

Circuit Block

3. Measurement method of fair/defective thermal fuse



Fail



Defective

10-4 ASSY WIFI KIT Inspection Method

10-4-1 Status-LED Blinking with interval 0.5s

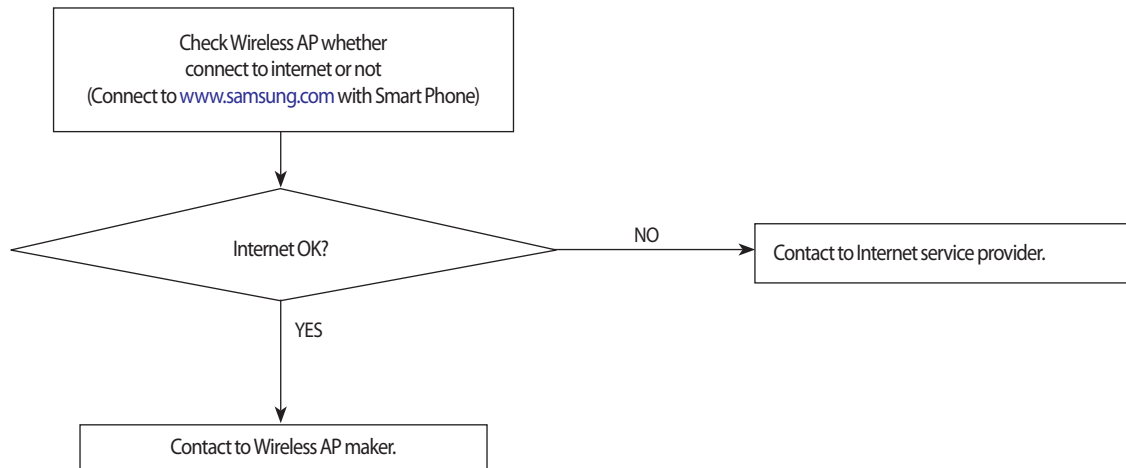

10-4-2 Status-LED Blinking with interval 3s

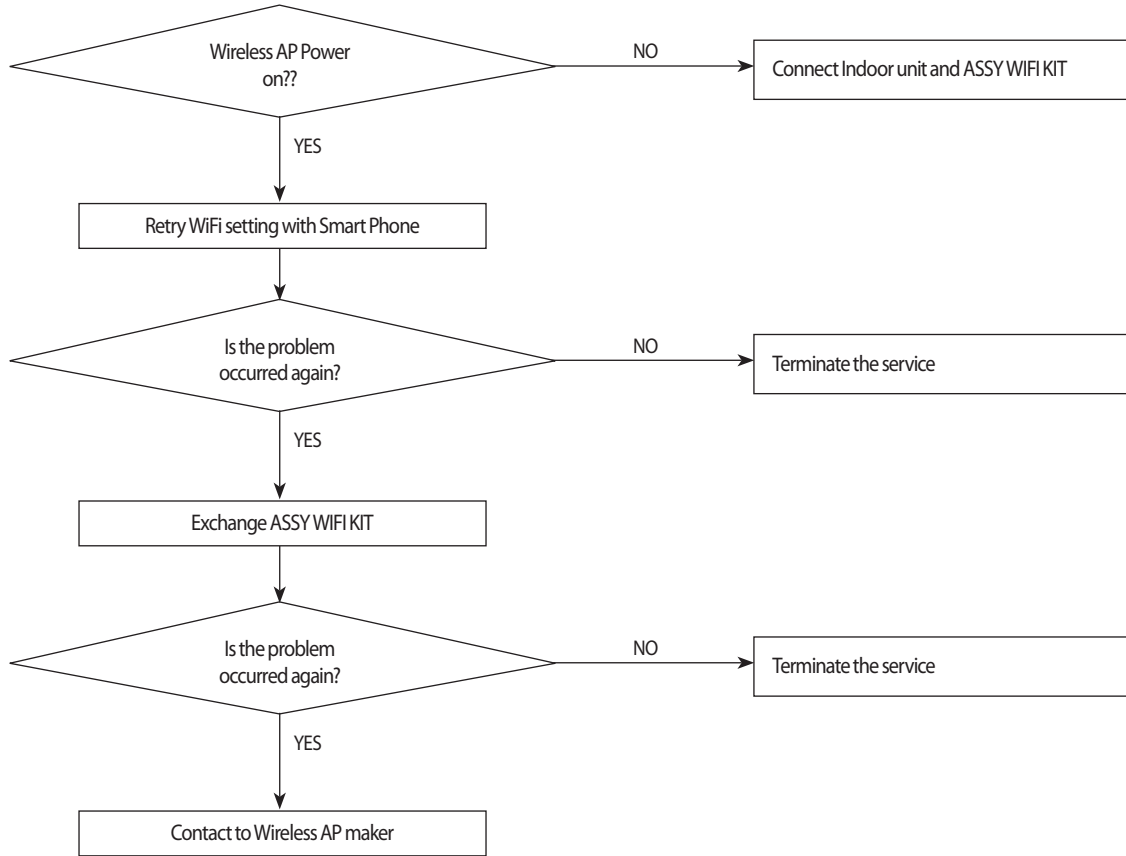

<< **Status LED Indication** >>

- 1. LED ON : Connected with AP & INTERNET
- 2. LED Blinking (Interval of 0.5s) : Connected with AP but not connected with INTERNET
- 3. LED Blinking (Interval of 3s) : Not connected with AP
- 4. LED OFF : Not connected with Air Conditioner

10-4-3 Status-LED OFF

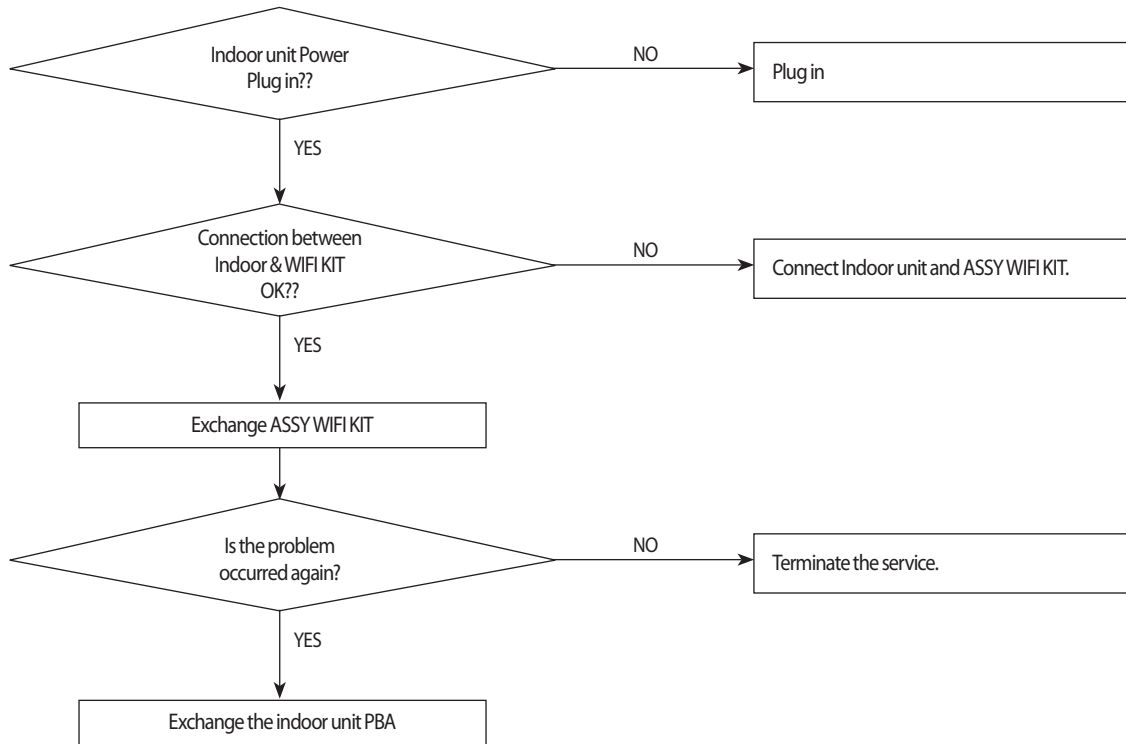

11. Block Diagram

11-1 Indoor unit

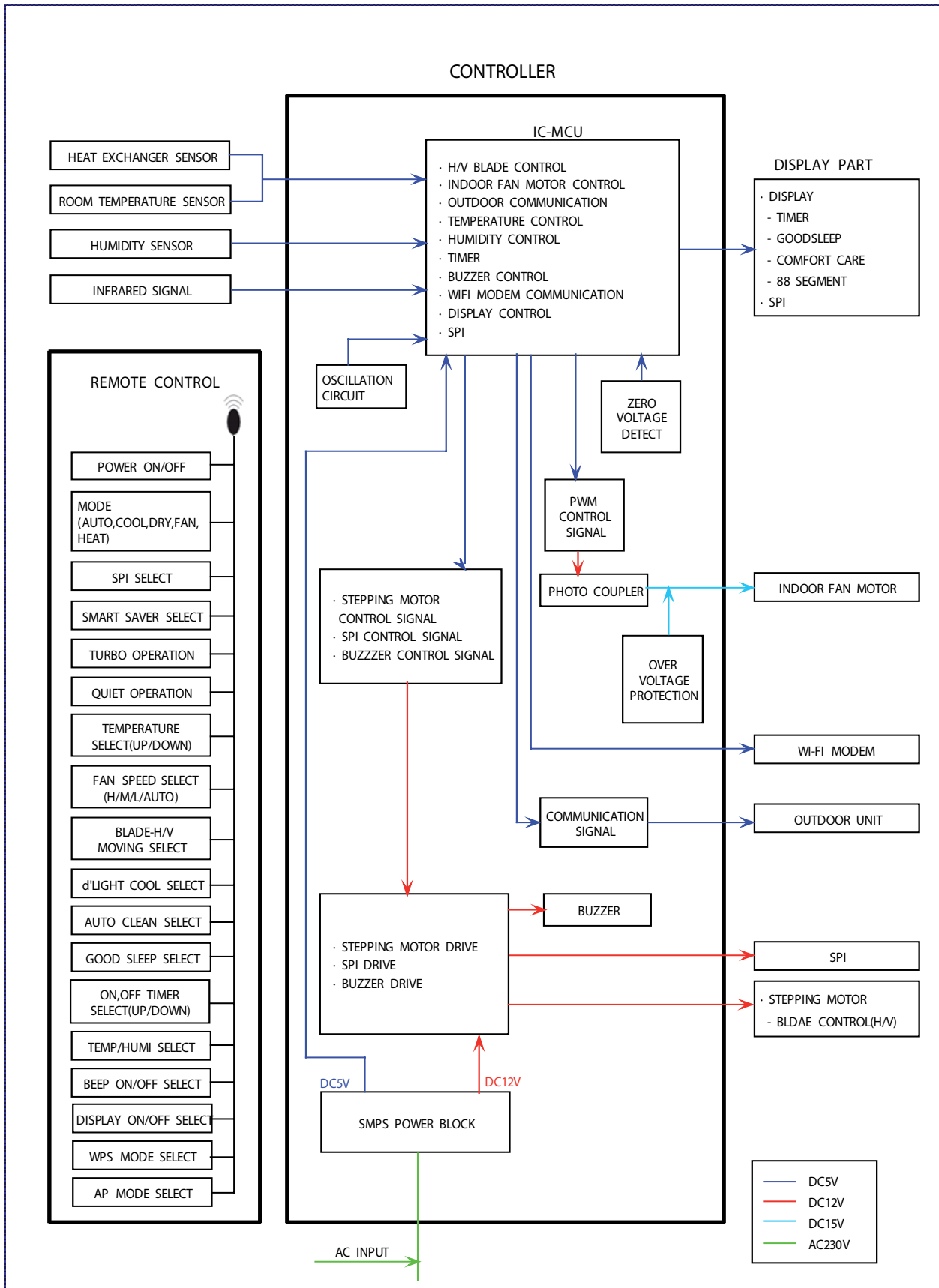

11-2 Outdoor unit

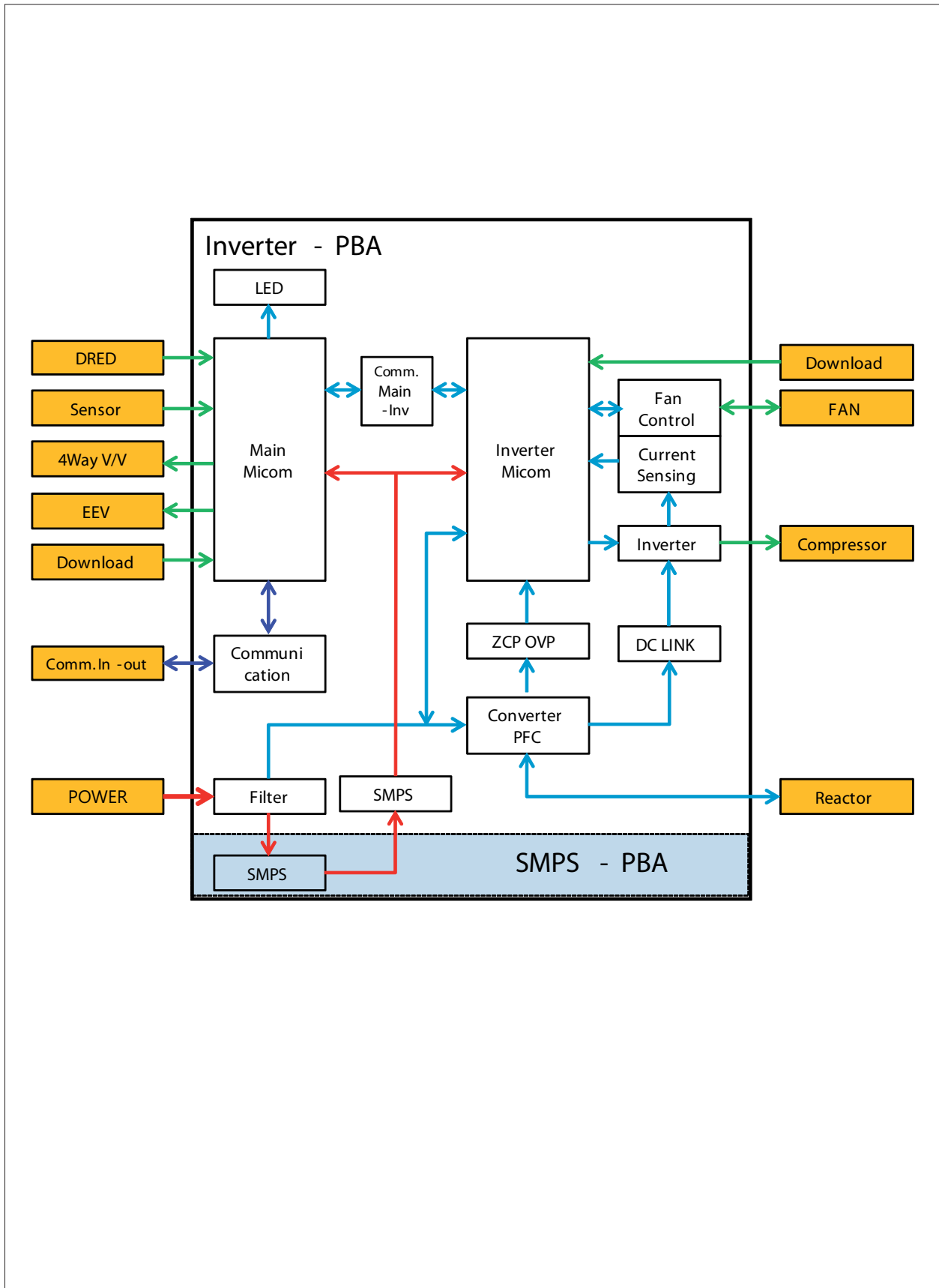

11-2-1 Pre-inspection Notices

1. Check if you pulled out the AC power plug when you eliminate the PCB or front panel
2. Don't hold the PCB side not impose excessive force on it to eliminate the PCB
3. Don't pull the lead wire but hold the whole housing to connect or disconnect a connector to the PCB
4. In case of outdoor PCB disassembly, check first the complete discharge of condenser after 1 minute power off

11-2-2 Inspection procedure

1. Check connector connection and peeling of PCB or bronze coating pattern when you think the PCB is broken
2. The PCB is composed of 3 parts
 - Indoor Main part : MICOM and surrounding circuit, relay, fan motor sensing and driving circuit, temperature sensing circuit power circuit of SMPS, buzzer circuit. Communication circuit
 - Display part : LED lamp, Switch, Remote-control module
 - Outdoor Main part : MICOM and surround circuit, fan motor sensing and driving circuit, compressor driving circuit power circuit of SMPS, PFC control circuit, 4way circuit, communication circuit, OPTION (EEV control circuit, temperature sensing circuit)

11-2-3 Indoor detailed inspection procedure

No	Procedure	Inspection Method	Cause
1	Plug out and pull the PCB out of the control box Check the PCB fuse	1) Is 1st fuse disconnected? 2) Is 2nd fuse disconnected?	. Over current . Indoor Fan motor short . AC part and pattern short of Indoor PBA
2	Supply power If the operating lamp twinkles at this time, the above 1)~3) have no relation	Check the power voltage	
		1) Is the BD71 input voltage 200Vac~240Vac?	. Power cord is fault, Fuse open, Wrong Power cable Wiring, AC part is faulty
		2) Is the voltage between both terminal of IC02 pin #1-#2 12Vdc?	. Switching Trans of Power circuit is faulty
3	Press the ON/OFF button 1. Fan speed(high) 2. Continuous Operation	3) Is the voltage between both terminal of IC02 pin #2-#3 5Vdc?	. Power circuit is faulty, Load short
		1) Is the voltage over AC 180V being imposed on terminal #3-#5 of fan motor connector (CN72)?	. Fan motor of the indoor is faulty
		2) The fan motor of the indoor unit doesn't run	. Fan motor connector(CN72) is faulty
		3) The power voltage between terminal #3-#5 of the connector(CN72) is 0V	. PBA is faulty

11-2-4 Outdoor detailed inspection procedure

No	Procedure	Inspection Method	Cause
1	Plug out and pull the PCB out of the control box Check the PCB fuse (Wait 3 minutes after power off)	1) Is 1st fuse disconnected?	. Over current . AC part and pattern short of Outdoor PBA
2	Check the Wiring	1) Is the Compressor wire connected clockwise? 2) Is the Reactor wire connected normal? 3) Is the Fan wire connected normal? 4) Is the 4way wire connected normal? 5) Is the sensor wire connected normal? 6) Is the EEV wire connected normal?	. Wrong assembly . Installation(service) condition is bad
3	"Supply power and operate the set (Use Remote-control, button in indoor set)"	Check the power voltage	
		1) Is the voltage between Terminal block L-N 200Vac~240Vac?	. Power cord is faulty, Wrong Power cable Wiring
		2) Is the C006 voltage 200Vac~240Vac?	. Fuse open . L,N,F1,F2 wire wrong wiring (Terminal Block-PBA)
		2) Is the CN150 voltage 200Vac~240Vac?	. Power circuit is faulty . Load short
		4) Is the PFC050(#26-#27) voltage 200Vac~240Vac after 3 minutes later?	. Fuse open . L,N,F1,F2 wire wrong wiring (Terminal Block-PBA) . PTC020 open . RY021, RY022 is faulty . Outdoor Micom(IC201) error
		5) Is the CE101 voltage 280Vdc~320dc after 3 minutes later?	. PFC050 is faulty . Reactor wire is wrong connection . Power circuit is faulty, Load short . BLDC Fan motor error
		6) Is the voltage CN151 #1-#2 voltage 15Vdc?	. Switching Trans of Power circuit is faulty . Load short
		7) Is the voltage CN152 #1-#2 voltage 12Vdc?	. Switching Trans of Power circuit is faulty . Load short
		8) Is the voltage CN151 #3-#2 voltage 5Vdc?	. Switching Trans of Power circuit is faulty . Load short
4	Check the LED lamp display	1) Normal : RED on, GRN blink, YEL off 2) Abnormal - All off : check no power - abnormal display : check error mode	. F1,F2 wire wrong wiring . Outdoor PBA is faulty

12. Reference Sheet

12-1 Low Refrigerant Pressure Distribution

Note : Please measure the refrigerant pressure after the air conditioner operates on testing cooling mode during more than 10 minutes.

- Indoor Temp. Variation : 20°C ~ 32°C
- Outdoor Temp. Variation : -5°C ~ 45°C

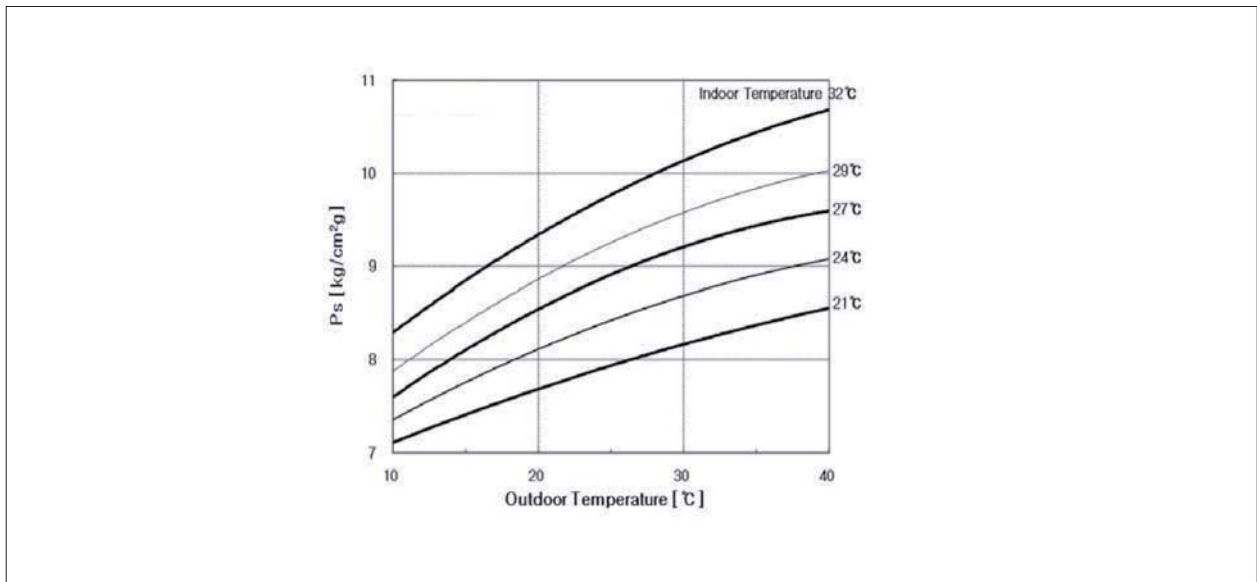

12-2 Pressure & Capacity mark

■ Power/Heat

W	cal/s	kcal/h	Btu/h	HP	kg.m/s	lb.m/s
1	0.23885	0.85985	3.4121	0.001341	0.10197	0.73756
4.1868	1	3.6	14.286	0.0056146	0.42693	3.088
1.163	0.27778	1	3.9683	0.0015596	0.11859	0.85778
0.29307	0.06999	0.252	1	3.9302x10 ⁻⁴	0.029885	0.21616
745.7	178.11	641.19	2,544.4	1	76.04	550
9.8067	2.3423	8.4322	33.462	0.013151	1	7.233
1.3558	0.32383	1.0658	4.6262	0.0018182	0.13826	1

12-3 Q & A for Non-trouble

Classification	Class	Description
Cooling	Q	The cooling is weak.
	A	When it is hot outside, its cooling capacity decreases due to the increase of the ambient temperature. When the dust filter gets blocked or warm outside air gets in, the cooling capacity will decrease. So, make sure to clean the dust filter frequently, prevent heat loss by closing the doors and insulate the cooling area by using curtains, blinds, shades or window tinting.
	Q	The cooling is good generally. But, it gets weak when it is considerably hot.
	A	It occurs when the outdoor unit is exposed to direct sun light and heat-up air is not ventilated well. So, set up a sunblind over the outdoor unit and keep stuff away from the unit to increase the ventilation. When the cooling capacity decreases during a heat wave, clean the heat exchanger of the outdoor unit or spray some cold water to the heat exchanger to increase the cooling capability.
	Q	The cooling is weak. Does it need refrigerant charging?
	A	It is not correct charging refrigerant regularly. Except that you have moved in several times or the connection pipes are broken, the refrigerant does not run low. So, when refrigerant is additionally charged, it could be costly and cause a product's failure. When the refrigerant leaks, all of it will escape in a short time resulting in cooling failure and no water coming out of the drain hose. So, if water comes out from the drain hose, it indicates the normal operation of the product and it does not need refrigerant charging.
	Q	It fails to do cooling.
Leakage	A	When the air conditioner is set to ventilation or the desired temperature is set higher than the current temperature, it fails to do cooling. In this case, select cooling or set the desired temperature lower.
	Q	It floods the floor.
	A	Place the drain hose properly. When it is not placed properly, the drain water would flow back flooding the floor. So, straighten out the drain hose for the water to be drained well.
	Q	Water drips at the drain connection (service valve) of the outdoor unit.
	A	When a glass bottle is taken out of the refrigerator, moisture gets condensed on its surface due to the temperature differences. The same principle applies to the air conditioner. When cold refrigerant goes through the copper tube, moisture gets condensed on the surface of the tube and the connection areas. To prevent the water condensation, the pipes are insulated. But, the connection areas of the outdoor unit are not insulated for the purpose of maintenance or repair, and water gets condensed due to the temperature differences and drips down. Generally, it evaporates right away. But, when it drips much during muggy days, put a water pan on the floor.
	Q	It leaks even though a drain pump is used.
Smells	A	It occurs when the drain pump is plugged out or it is out of order. Check the power of the drain pump and the position of the drain hose, and when the pump is faulty, contact the drain pump manufacturer. Samsung Electronics do not manufacture drain pumps. So, we are not able to correct the drain pump problems.
	Q	Whenever the air conditioner is turned on, it irritates my eyes and gives me a headache.
Smells	A	There are no components in the air conditioner irritating the eyes and sending out chemical smells. But, when the air conditioner is turned on, other smell sources are sucked into the air conditioner and get out of it. So find and root out the smell sources. Generally, it occurs at a interior renovated place, a pharmacy, a gasoline handling place, a tire shop, a second-hand book shop or an electronic component handling place, when its chemical or musty smells are sucked in and sent out, it can be misled that the air conditioner generates them.

Classification	Class	Description
Smells	Q	Whenever the air conditioner is turned on, it stinks.
	A	When are no components in the air conditioner sending out chemical smells. But, when the air conditioner is turned on, other smell sources are sucked into the air conditioner and get out of it. So, find and root out the smell sources. Generally, when the drain hose is taken out to the washing room or there are sources of smells such as a diaper bin, a shoe shelf or a socks bin, bad smells generate. Also, it occurs where glass cleaners or air fresheners are used; when they are sucked in interacting with dusts and moistures inside, bad smells generate. these kinds of organic materials noxious to human bodies. So, we recommend against the use of them.
	Q	Whenever the air conditioner is turned on, it smells sour.
	A	When the room is papered recently, its paste smells would be sucked inside. Also, when the air conditioner is installed in the study room of young boys loving sweat-generating activities such as the basketball, excessive sweats evaporate and get sucked into the air conditioner resulting in bad smells. So, find and root out problem or refresh the room frequently.
	Q	Whenever the air conditioner is turned on, it smells musty.
	A	It is due to the improper keeping of the product after its use. When keeping the product, dry up the inside with the operation of ventilation to prevent must. When the product is kept without drying up the inside with ventilation, mold would grow inside resulting in must. So, open the windows and switch on the ventilation function to get rid of the saturated smell inside.
	Q	Whenever the air conditioner is turned on, it sends out bad smells such as stale smells.
	A	It occurs generally when there are pet animals in the house. Their smells stay at the same place. But, when the air conditioner is turned on, the air gets circulated resulting in the circulation of the smells. So, find and root out the problem or refresh the room frequently.
	Q	It sends out bad smells.
Operation	A	When the air filter is filthy, it could send out bad smells. So, clean the filter and ventilate the room with the windows open while operating the ventilation function.
	Q	It won't start.
	A	There is a power failure or it is plugged out. Also, check if the power distribution panel is switched off.
	Q	It goes off during operation.
	A	When the hot air does not escape properly, it goes off during operation. it occurs when it does not ventilate properly because the outdoor unit is covered, the back of the outdoor unit is blocked by a cardboard or a plywood panel, and the front of the outdoor unit is blocked by the closed window or other obstacles. Clear the above obstacles from the outdoor unit.
	Q	It generally works properly. But, when it's considerably hot, it goes off during operation.
	A	It occurs when the outdoor unit is exposed to direct sunlight and the hot air does not escape properly. Set up a sun blind over the outdoor unit and clear the neighboring obstacles from the outdoor unit to provide good ventilation. When it goes off frequently during a heat wave, it would prevent the turn-off and increase the cooling capacity cleaning the outdoor unit or spraying some water to the heat exchanger.
	Q	The remote controller won't operate.
A	When the batteries run out or the transmitter or receiver of the remote controller is blocked by obstacles, change the batteries or keep the obstacles away from the controlling area. Also, the remote controller may not work under intensive light from a 3-wave length lamp or a neon sign due to the EMI. In this case, take the remote controller closer to the receiver.	

Classification	Class	Description
Installation	Q	Who installs the air conditioner? (Relocation/Re-installation)
	A	When relocating or re-installing the air conditioner, make sure to contact Samsung Electronics Service Center or Authorized Service Agent and have them to do the job. (If not, it could cause personal injury or product damage.) The cost for the relocation/re-installation of the air conditioner is subject to the customer's expense. There is a cost table. But, our service engineer needs to visit to total up the cost correctly. When you move in, make sure to contact Samsung Electronics Service Center or Authorized Service Agent in advance to streamline the process.
	Q	Is it possible to install the outdoor unit outside?
	A	It is possible to install it at a designated place in the apartment or on the rooftop nearby. But, it's illegal hanging an angle iron case with the outdoor unit in it outside the apartment. Also, it is illegal obstructing passers-by with the outdoor unit installed outside.
	Q	What can be done to install the outdoor unit facing the road because it is a commercial building?
	A	The following is an excerpt from building code going into effect from JUNE 1 st 2005. "The exhaust pipe of a cooling or ventilation facility installed in a building adjacent to the streets of commercial or residential areas shall be installed higher than 2 m to prevent the exhaust air from blowing directly to passers-by and the current facilities shall be corrected by MAY 31 st 2005." So, please install it higher than 2 m or not to blow the hot exhausting air directly to passers-by.
	Q	What about installing a windscreen during installation not to blow hot air directly to passers-by?
A	When the hot air from the front of the outdoor unit is blocked, the product's performance will be affected and it will fail to operate properly. So, keep it at least 300mm away from its surrounding walls and give it good ventilation.	

12-4 Cleaning /Filter Change

12-4-1 Cleaning your Air Conditioner

To get the best possible use out of your air conditioner, you must clean it regularly to remove the dust that accumulates on the air filter.

Removing the Air filter

There is a hole on the bottom right side of the filter. Put your finger in that hole to get a grip on the filter and slightly push it up to release the hooks from the bottom side. Then, pull it down to remove the filter from the main body.

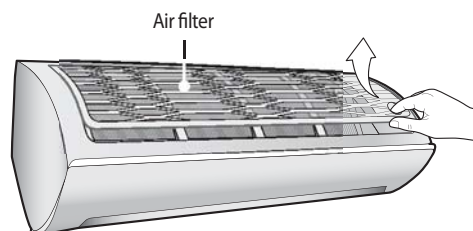

Cleaning the air filter

Washable foam based air filter captures large particles from the air. The filter is cleaned with a vacuum or by hand washing.

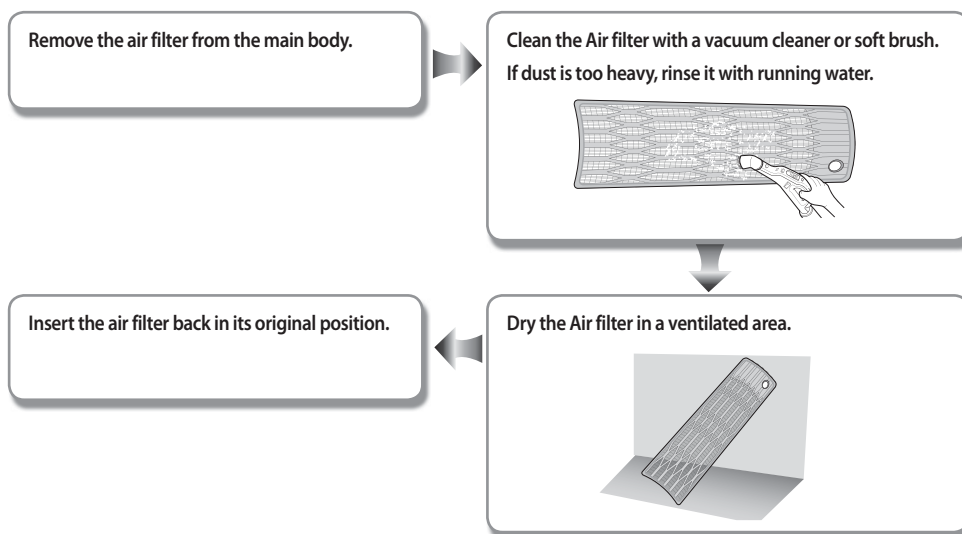

- Clean the Air filter every 2 weeks. Cleaning term may differ depending on the usage and environmental conditions. In dusty area, clean it once a week.
- If the Air filter dries in a confined (or humid) area, odors may generate. If it occurs, re-clean and dry it in a well-ventilated area.
- When the filter clean reminder is on, please press the 2nd F button and then press the ECO Run button on remote controller.

12-5 Installation

12-5-1 Before Installation

Keep the air conditioner outlet and inlet free from its surroundings.
In case of installation, keep the symmetry and fix it to prevent vibration.
The pipe length shall meet the standard as far as possible.

12-5-2 Installation Procedure

■ Location

Install the product in an area to guarantee the best cooling effect, convenience of piping and electric work, and inexistence of vibration or wind.

■ Wall Drilling

Drill the wall downward in a diameter of 60 to 65mm.

■ Fixing Indoor Unit & Outdoor Unit

Fix the air conditioner indoor unit securely to the wall. Secure the outdoor unit in a suitable position.

■ Pipe Spooling & Connecting

You shall cut the pipe with a pipe cutter and grind all the burrs of the cut surface.
pipe expansion may continue until the pipe surface becomes uneven or torn apart.
Be sure to use a torque wrench to tighten pipes or flare nuts.

<Torque & Depth>

Outer Diameter (D)	Torque(kgf-cm)	Depth(A)
ø6.35 mm(1/4")	140~170	1.3 mm
ø9.52 mm(3/8")	250~280	1.8 mm
ø12.70 mm(1/2")	380~420	2.0 mm
ø15.88 mm(5/8")	440~480	2.2 mm
ø19.05 mm(4/4")	9900~1,210	2.2 mm

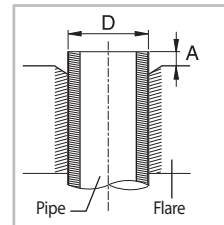

■ Leak Test

Put an inset gas like nitrogen in the outdoor unit pipe and put soap bubbles or other test liquids on the pipe surface for the leak test.

■ Drain Hose Connecting

Install the drain hose downward to drain water naturally. Be sure to pour water into the hose to check if it drains well.

■ Electric & Earth Work

Electric and earth work shall meet the "Electric Facility Technology Standard" and the "Internal Wire Regulation" of the Electric Business Laws.

■ Inspection & Trial Run

Upon completion of the tests, you shall make a trial run while you explain the main functions of the air conditioner to finish the installation.

12-6 Installation Diagram of Indoor Unit and Outdoor Unit

12-6-1 Air-Purge Procedure

1) Connect each assembly pipe to the appropriate valve on the outdoor unit and tighten the flare nut.



2) Connect the charging hose of low pressure side of manifold gauge to the packed valve having a service port (3/8" Packed valve) as shown at the figure.



3) Open the valve of the low pressure side of manifold gauge counter-clockwise.



4) Purge the air from the system using vacuum pump for about 30 minutes.
 - After that, please recheck that pressure is stabilized.
 - Close the valve of the low pressure side of manifold gauge clockwise.
 - Remove the hose of the low pressure side of manifold gauge.



5) Set valve cork of both liquid side and gas side of packed valve to the open position.



6) Mount the valve stem nuts to the 2 way and 3 way valve. And mount the service port cap to 3 way valve.



7) Check for gas leakage.
 - At this time, especially check for gas leakage from the 3 way valve's stem nuts, and from the service port cap.

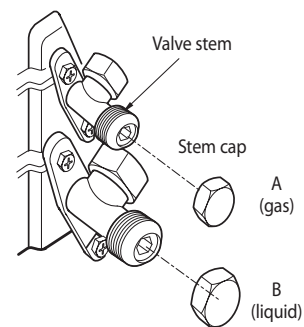
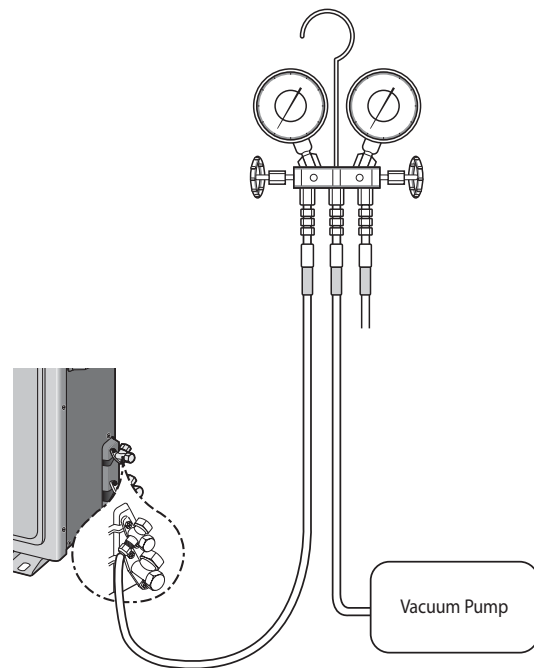
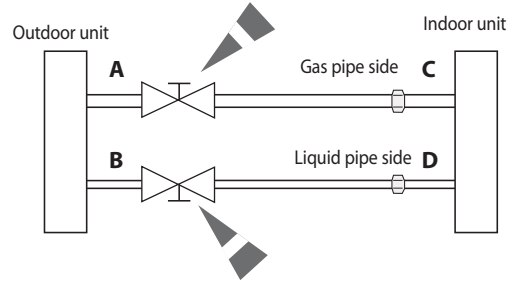

12-6-2 "Pump down" Procedure

Pump down will be carried out when an evaporator is replaced or when the unit is relocated in another area.

1) Remove the caps from the 3 way valve and the 3 way valve.



2) Turn the 3 way valve clockwise to close and connect a pressure gauge (low pressure side) to the service valve, and open the 3 way valve again.



3) Set the unit to cool operation mode.
(Check if the compressor is operating.)



4) Turn the 3 way valve clockwise to close.



5) When the pressure gauge indicates "0" turn the 3 way valve clockwise to close.



6) Stop operation of the air conditioner.



7) Close the cap of each valve.

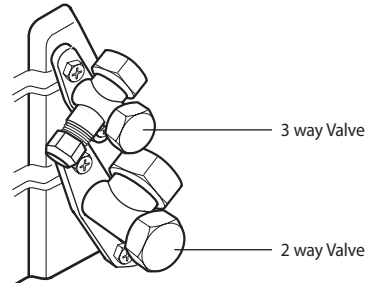

Remarks

Relocation of the air conditioner

- Refer to this procedure when the unit is relocated.
- Carry out the pump down procedure (refer to the details of 'pump down').
- Remove the power cord.
- Disconnect the assembly cable from the indoor and outdoor units.
- Remove the flare nut connecting the indoor unit and the pipe.
- At this time, cover the pipe of the indoor unit and the other pipe using a cap or vinyl plug to avoid foreign material entering.
- Disconnect the pipe connected to the outdoor unit.
At this time, cover the valve of the outdoor unit and the other pipe using a cap or vinyl plug to avoid foreign material entering.
- Make sure you do not bend the connection pipes in the middle and store together with the cables.
- Move the indoor and outdoor units to a new location.
- Remove the mounting plate for the indoor unit and move it to a new location.

12-7.Reference Sheet

Index for Model Name

* Project model code for overseas from 2007(For RAC Export Models)

Model Code

1st	2nd	3rd	4th	5th	6th	7th	8th	9th	10th	11th	12th	13th	14th
Project		Capacity		Sell	Feature		Series		Color		Unit	Export	
A	R	1	2	F	S	S	S	B	W	K	N/X	S	A

ITEM	1ST	2ND
RAC	A	R
FAC	A	F
WAC	A	W

Item	Reference	3TH	4TH
1	Export	0	9
2	Export	1	2
3	Export	1	8
4	Export	2	4
5	Export	3	0

Item	5TH
12Year	E
13Year	F
14Year	H
15Year	J
16Year	K

Item	6TH
INVERTER HP	S
INVERTER CO	V

Item1	Item2	7TH
Export	The virus doctor (The India / Latin America A / PAC K besides)	S
Export	NO virus doctor (the India / Latin America A / PAC K besides)	F

Special instructions:
About AR**FSSSCUR/SA ,the 7TH is "S", but there is no virus doctor in these models.

9TH DIGIT		
Export	1st MODEL	A
Export	2nd	B
Export	3rd MODEL	C
Export	4th MODEL	D
Export	5th MODEL	E

Item 1	Item 2	Item 3	8TH	9TH
Export	RAC	FMC FLG (Best)	1ST MODEL	F
Export	RAC	FMC DLX (Better)	1ST MODEL	D
Export	RAC	FMC STD (Good1)	1ST MODEL	S
Export	RAC	FMC ENT (Good2)	1ST MODEL	N

Division	Series	Project	Color Name	Division component	Sinkeolreo code (10TH,11TH)	Remark
A3050	F	Best	Twilight	Grille	WK	
	F	Best	TBD	Grille	TBD	
	D	Better	Twilight	Grille	WK	
	D	Better	TBD	Grille	TBD	
	S	Good1	Twilight	Grille	WK	Deco : Transparency
	S	Good1	Midnight Blue	Deco	UR	Grille : Twilight
	N	Good2	Twilight	Grille	WK	
	N	Good2	TBD	Grille	TBD	Grille : Metallic Gray

Item1	Item2	12TH
Export	SET	/
Export	IN	N
Export	OUT	X

Item	The existing code	The sales area	CIS Description	The integrated code (13TH,14TH)
1	XSA	AUSTRALIA	AUSTRALIA(XSA)	SA

● Except the RAC Export Models for China.



GSPN (GLOBAL SERVICE PARTNER NETWORK)

Area	Web Site
Europe, CIS, Mideast & Africa	gspn1.samsungcsportal.com
Asia	gspn2.samsungcsportal.com
North & Latin America	gspn3.samsungcsportal.com
China	china.samsungportal.com

This Service Manual is a property of Samsung Electronics Co., Ltd.
Any unauthorized use of Manual can be punished under applicable
International and/or domestic law.

© Samsung Electronics Co., Ltd. August. 2013.
Code No. AC-00045K_1